

Huffman Trees

BACADAEAFABBAAGAH

Fixed-Length Code

A	000
B	001
C	010
D	011
E	100
F	101
G	110
H	111

54 bits:

001000010000011000100000101000001001000000000110000111

BACADAEAFABBAAGAH

Fixed-Length Code

A	000
B	001
C	010
D	011
E	100
F	101
G	110
H	111

Variable-Length Code

A	0
B	100
C	1010
D	1011
E	1100
F	1101
G	1110
H	1111

54 bits:

001000010000011000100000101000001001000000000110000111

42 bits:

100010100101101100011010100100000111001111

BACADAEAFABBAAGAH

Frequency Table:

A	9
B	3
C	1
D	1
E	1
F	1
G	1
H	1

9:A

3:B

1:C

1:D

1:E

1:F

1:G

1:H

9:A

3:B

1:C

1:D

1:E

1:F

1:G

1:H



2:CD

1:C

1:D



9:A

3:B

2:CD

1:E

1:F

1:G

1:H

1:C

1:D



9:A

3:B

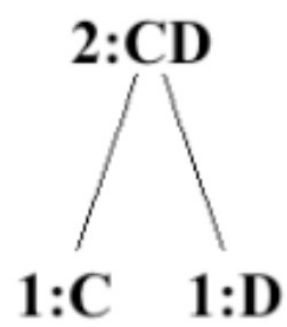

1:E

1:F

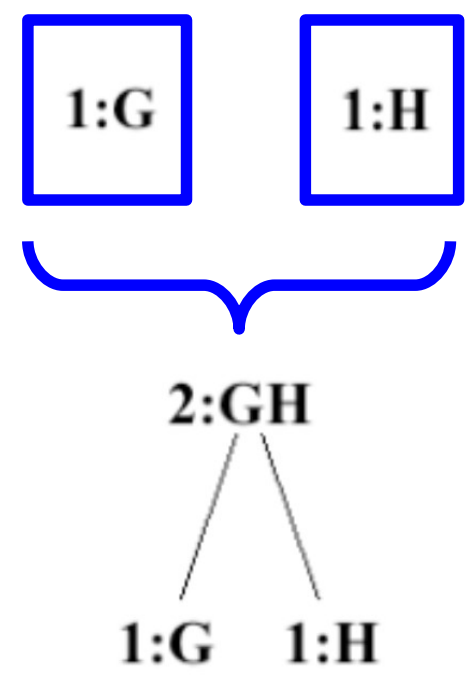

9:A

3:B

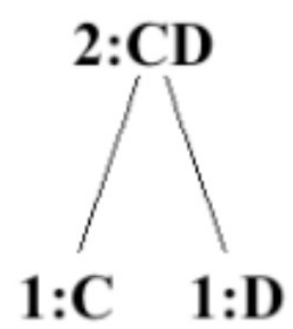

1:E

1:F



9:A

3:B

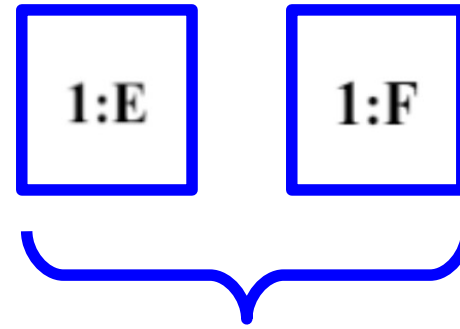
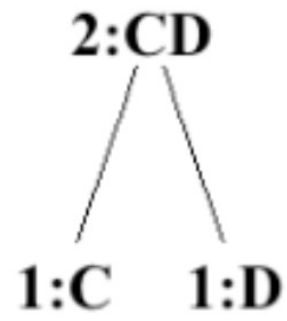

9:A

3:B

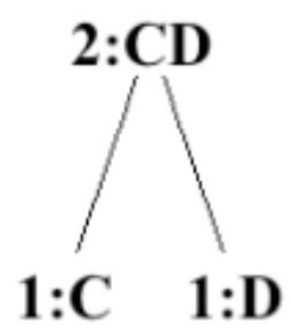

9:A

3:B

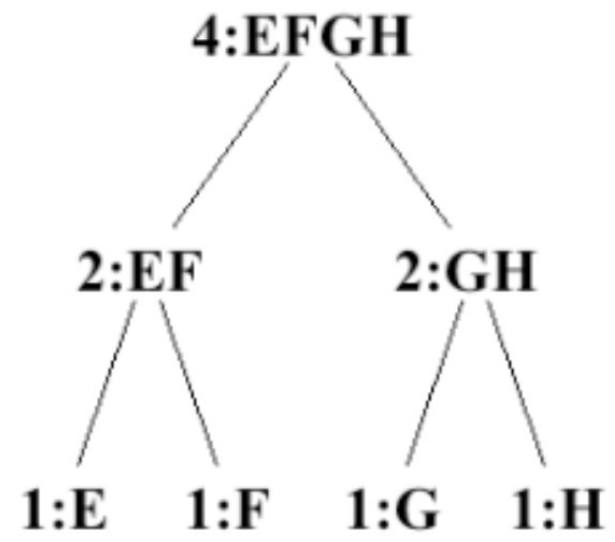
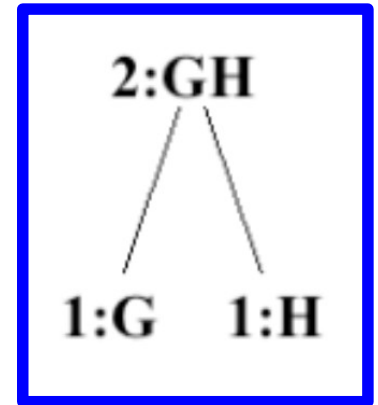
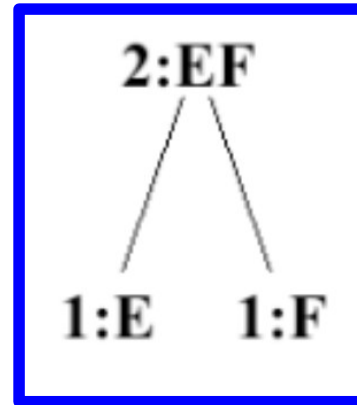
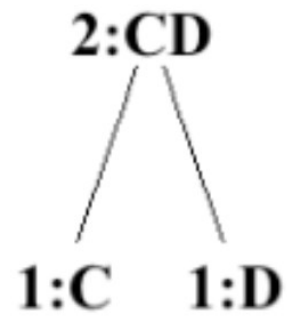

9:A

3:B

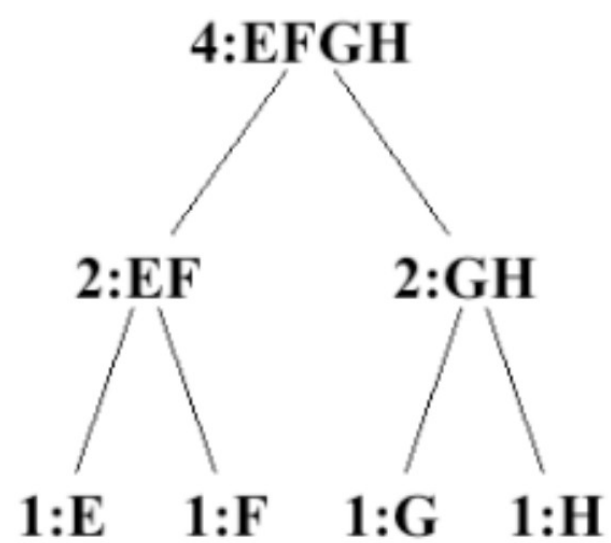
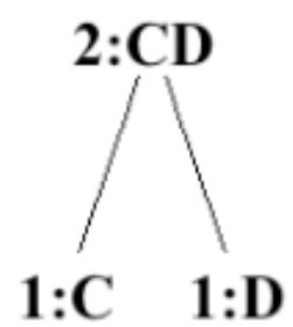

9:A

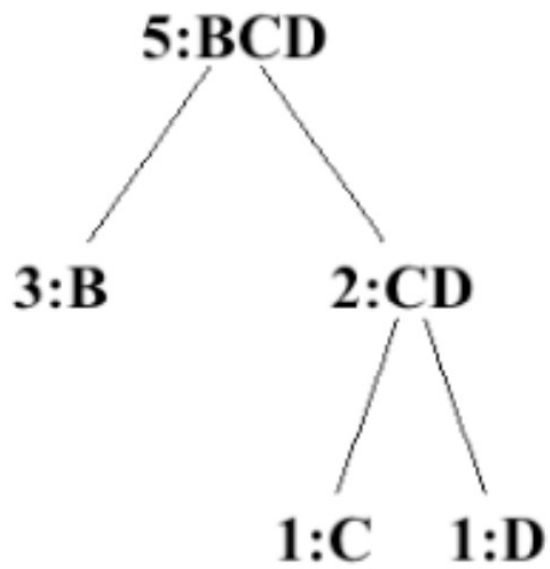
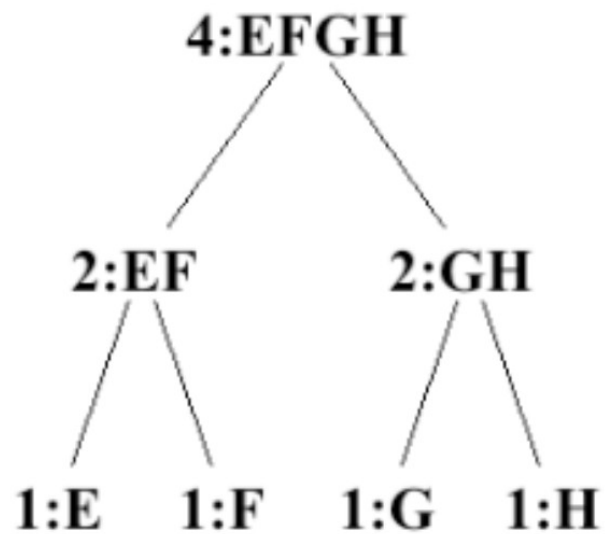
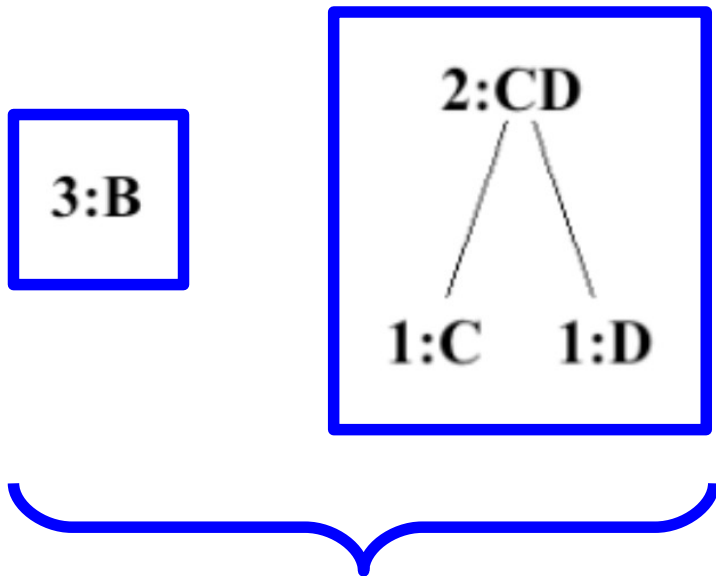

9:A

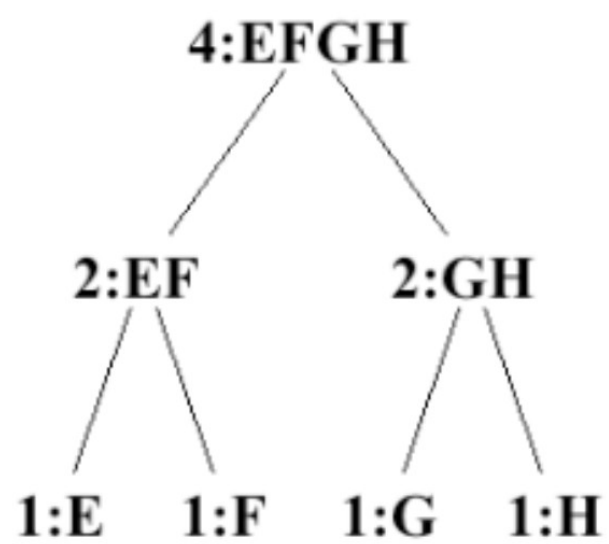
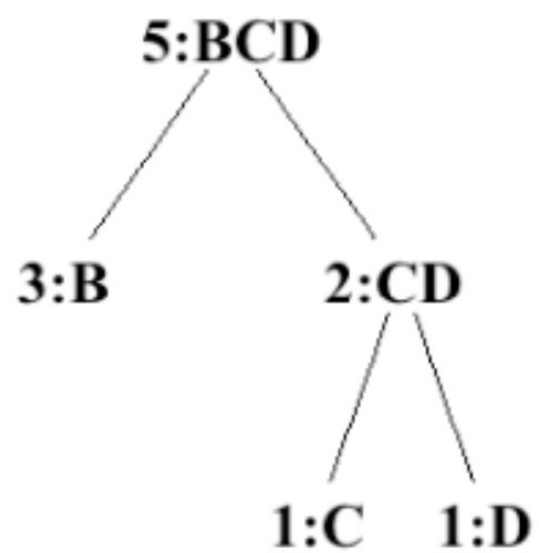

9:A

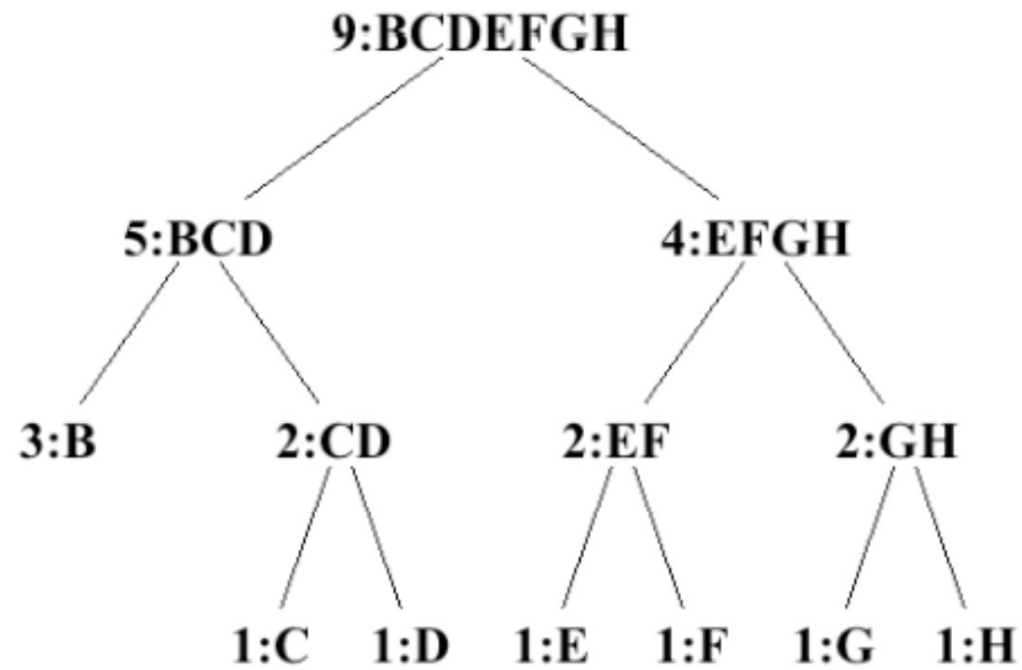
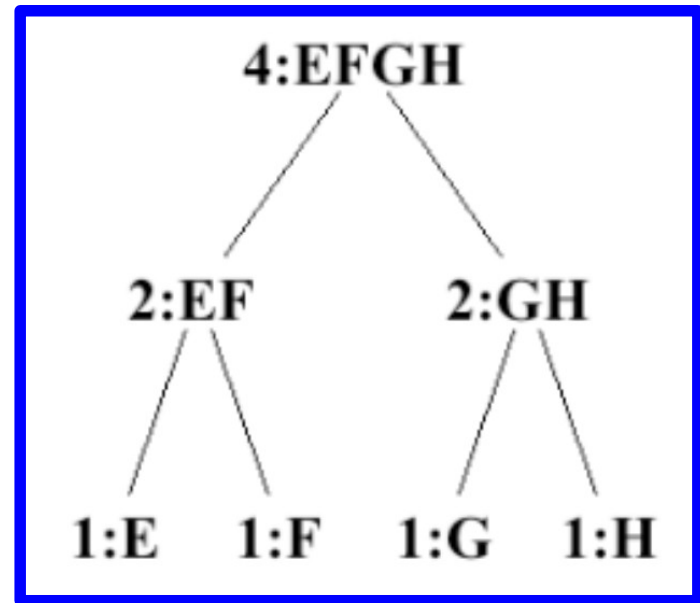
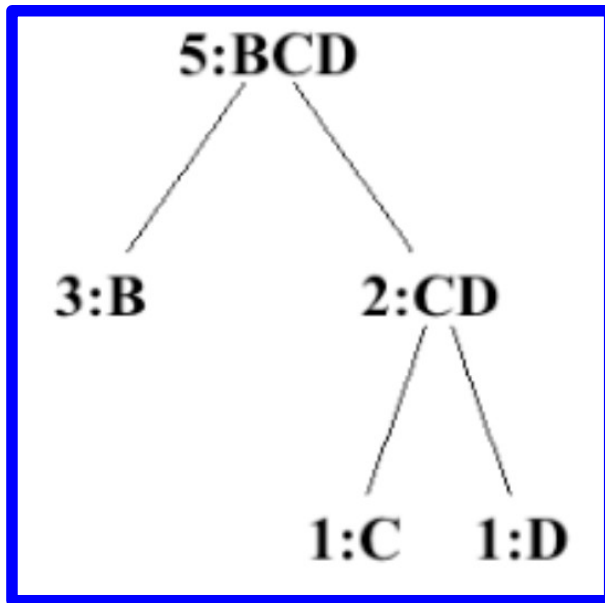

9:A

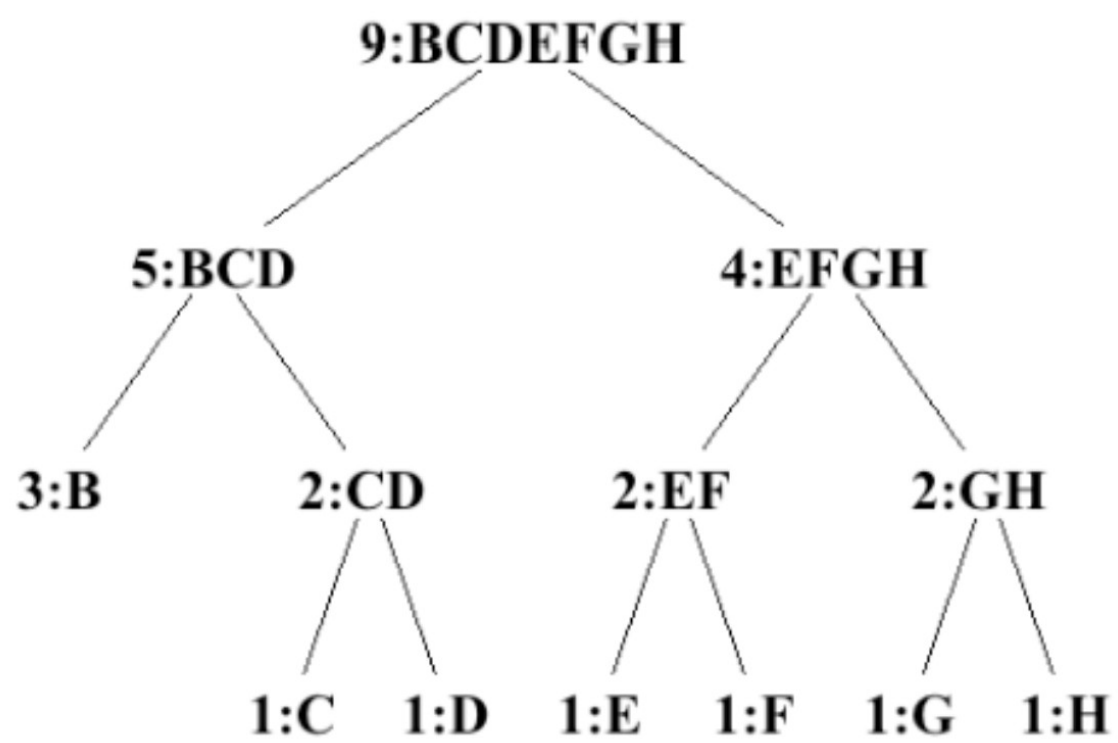

9:A

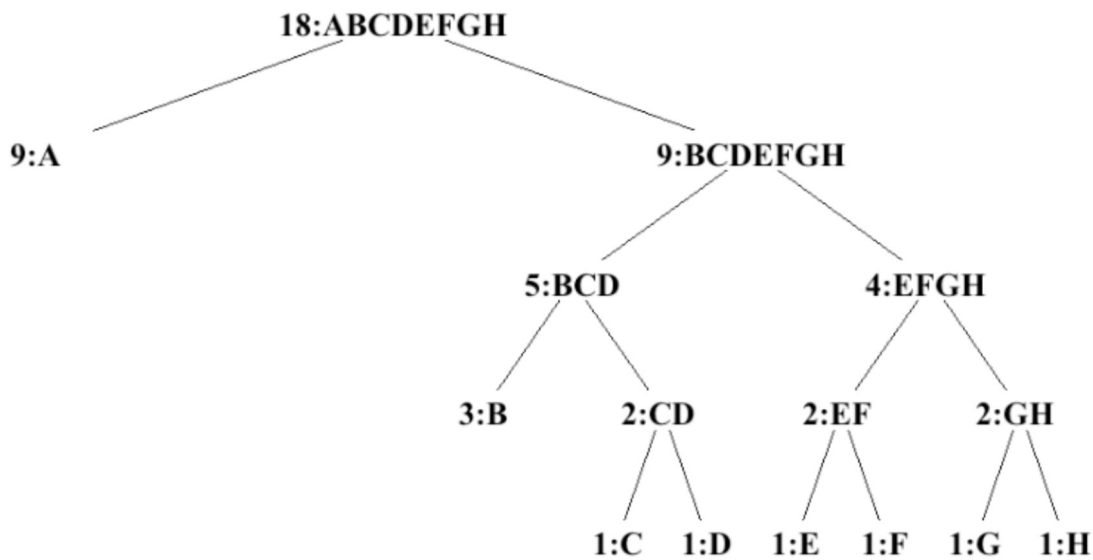
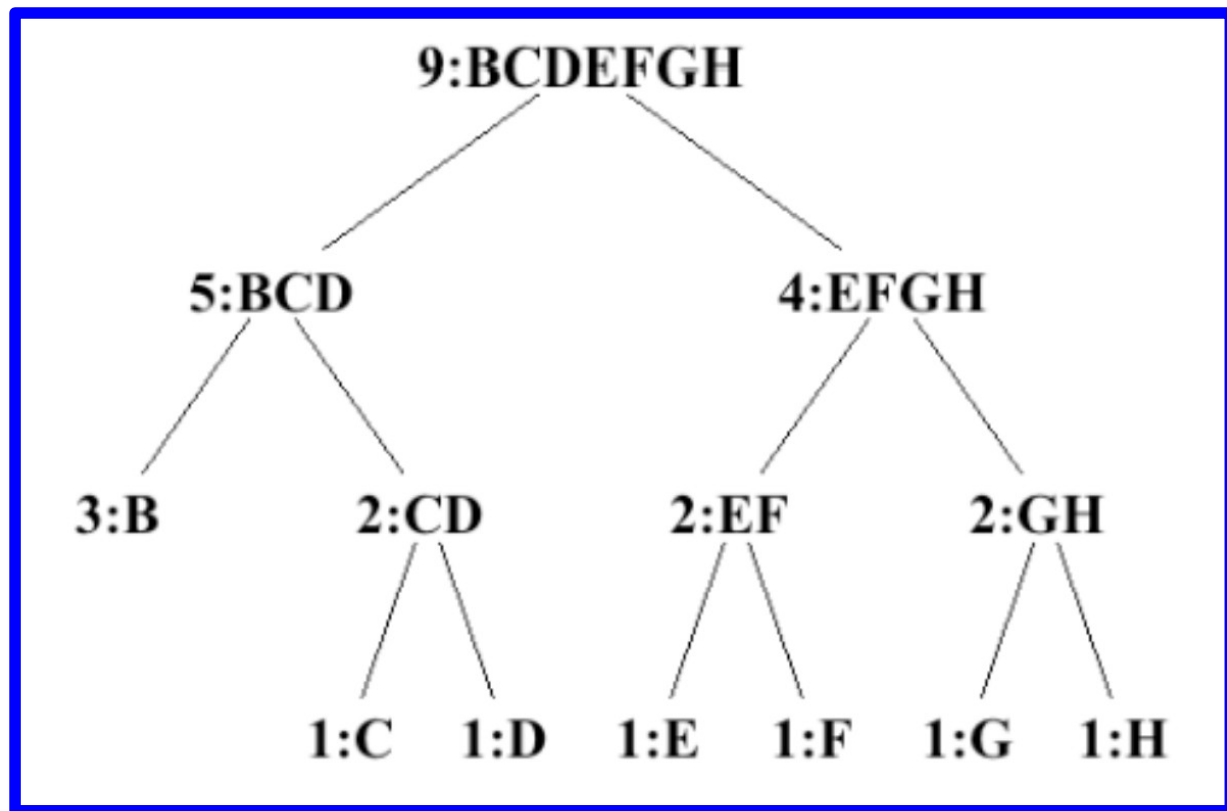

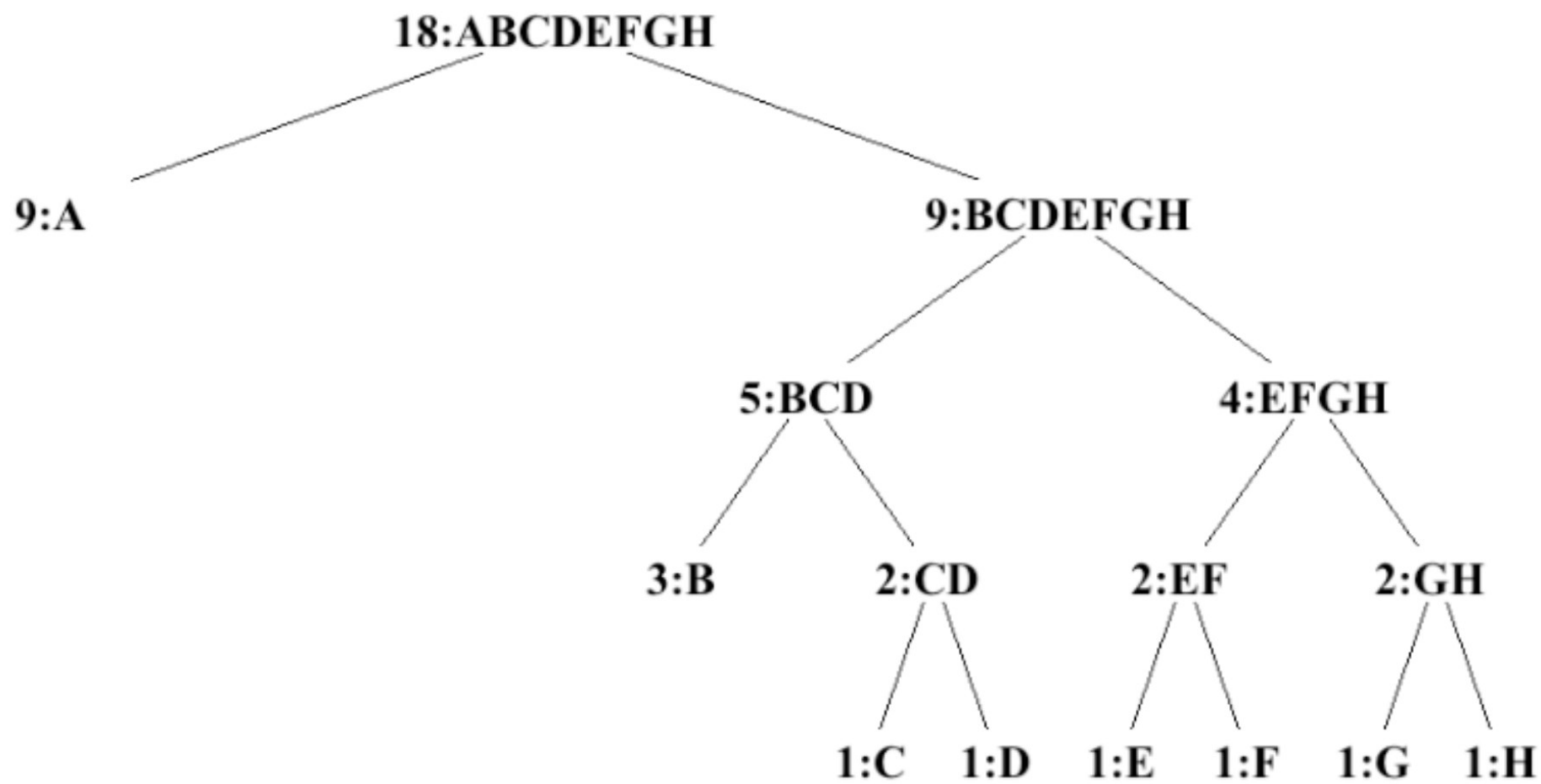

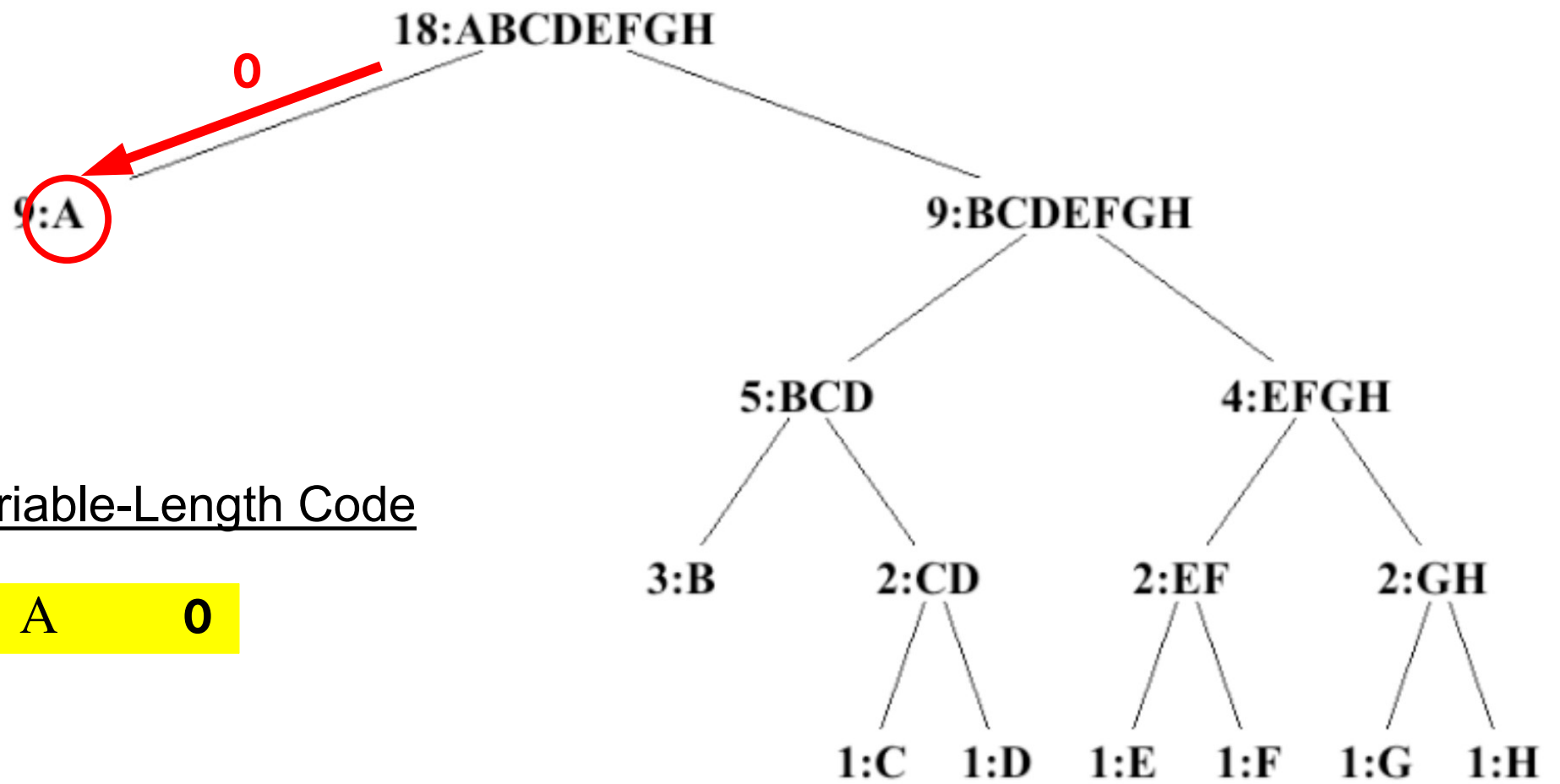

Variable-Length Code

A 0

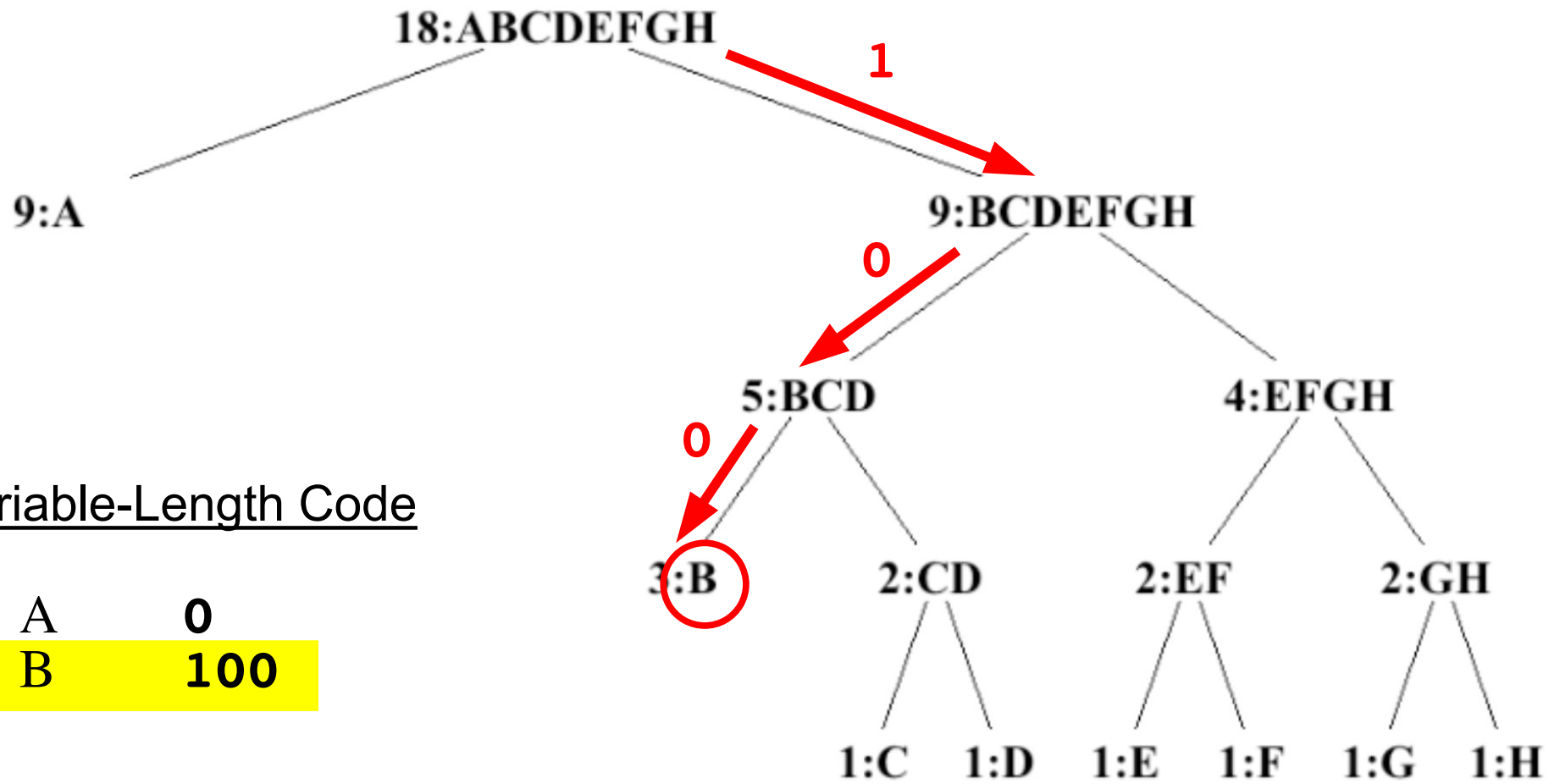

Variable-Length Code

A	0
B	100

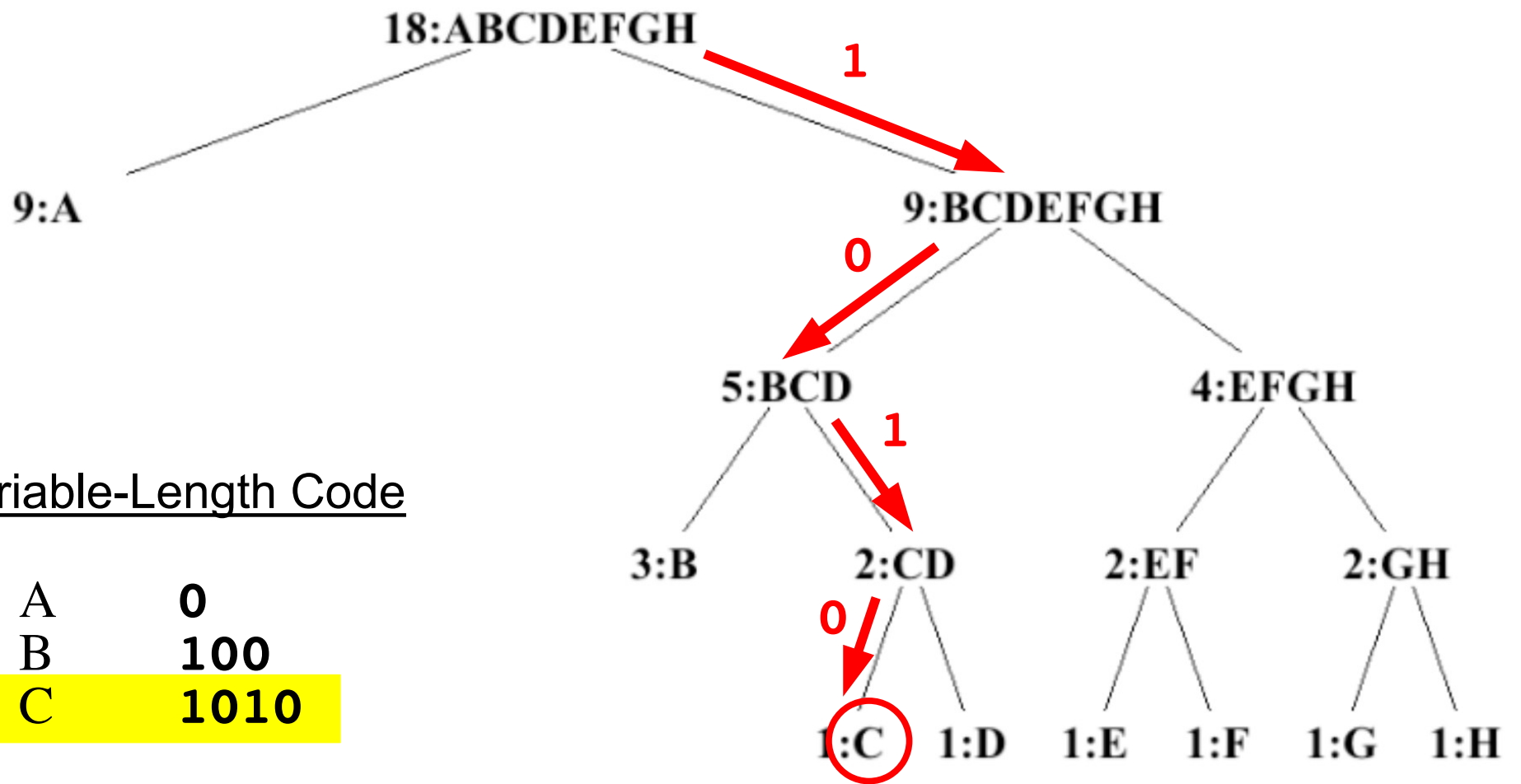

Variable-Length Code

A	0
B	100
C	1010

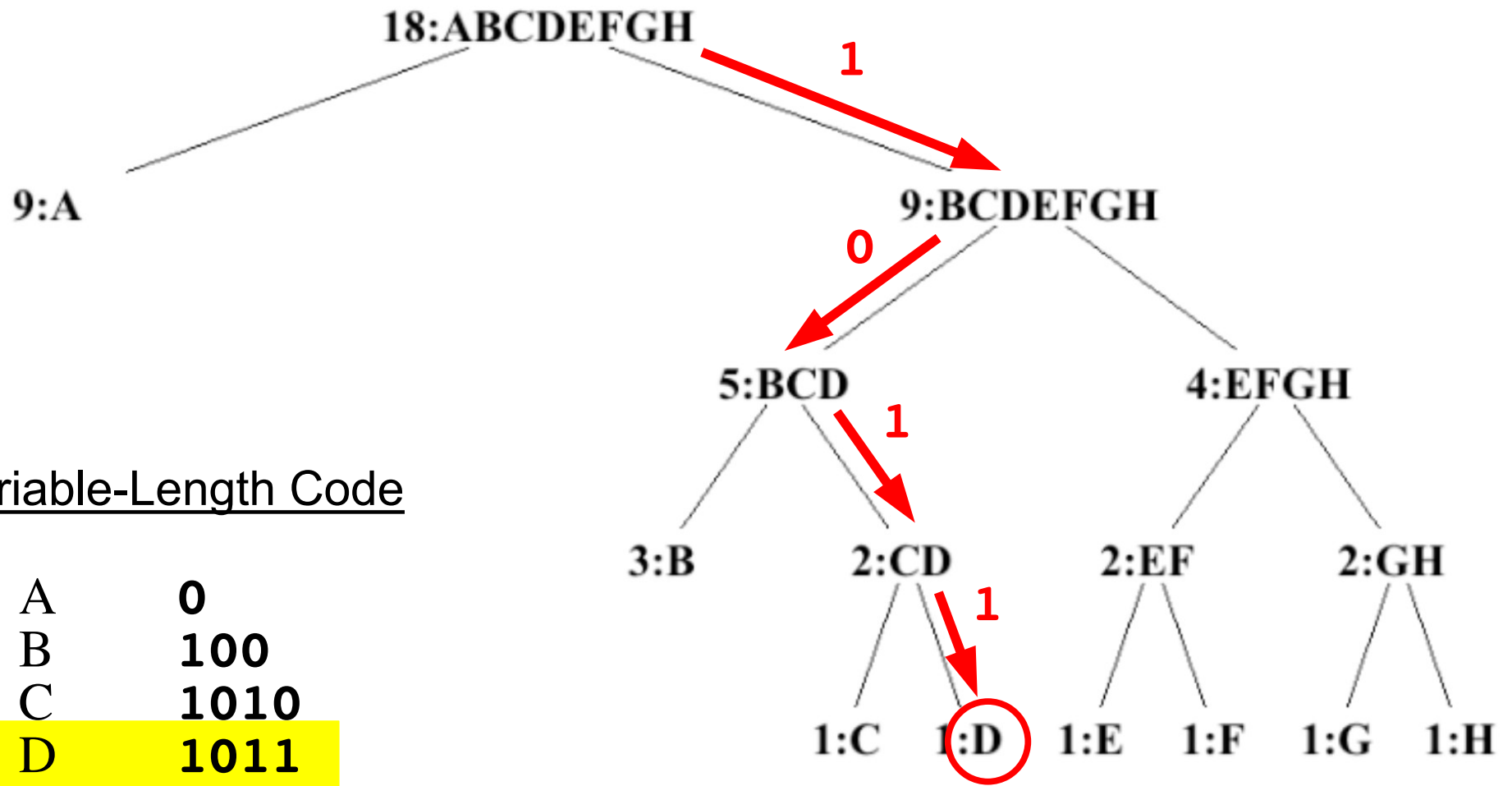

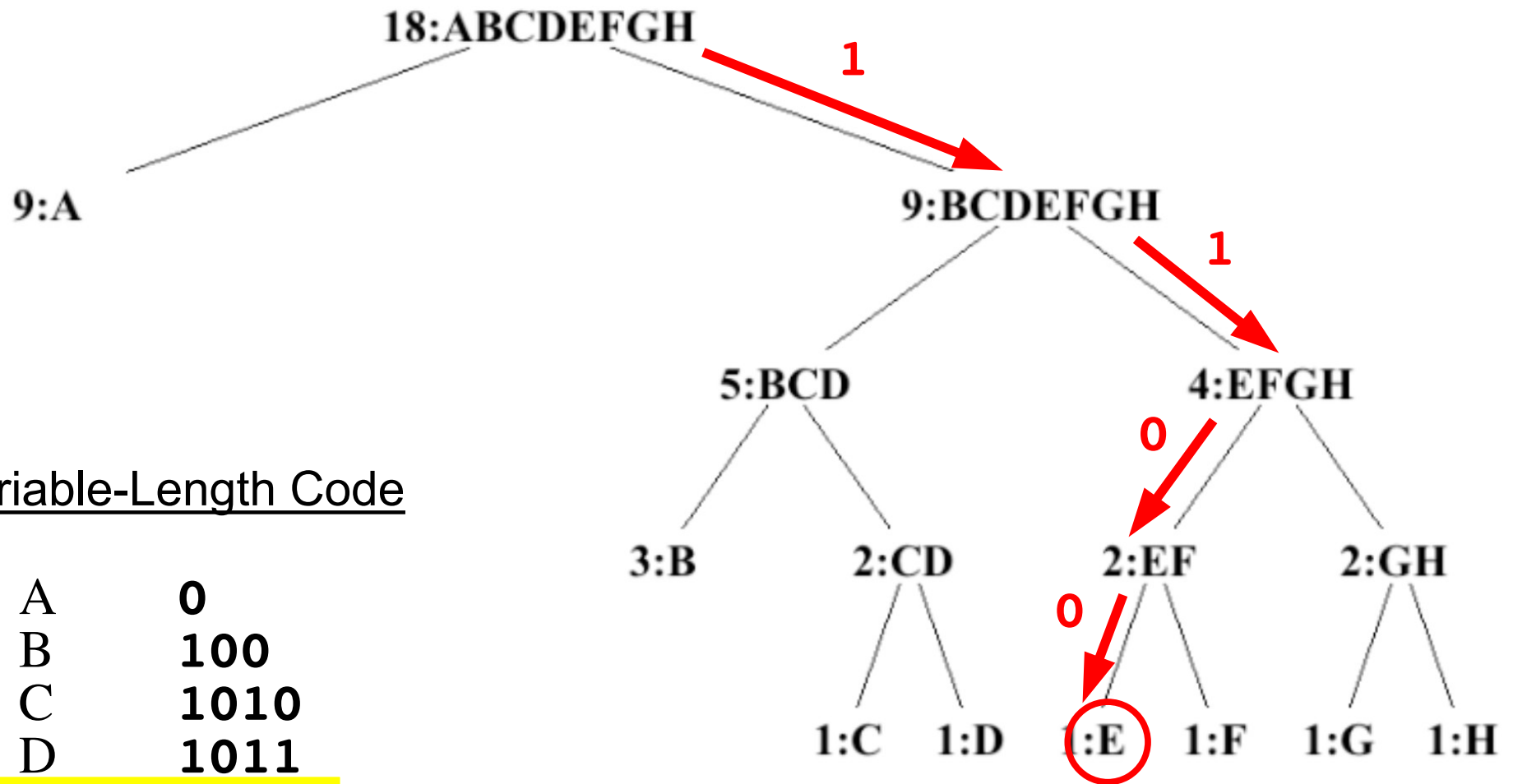

Variable-Length Code

A	0
B	100
C	1010
D	1011
E	1100

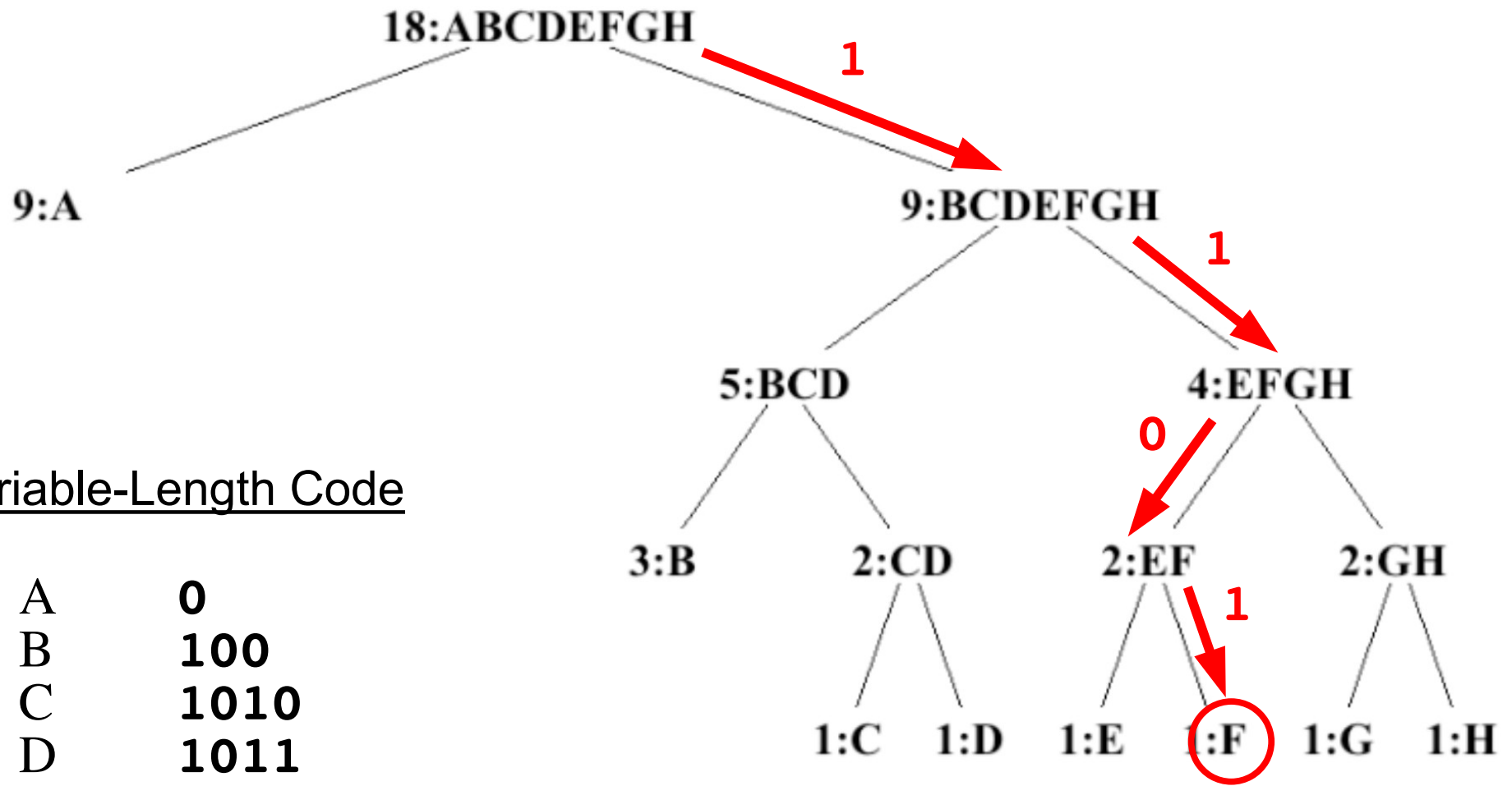

Variable-Length Code

A	0
B	100
C	1010
D	1011
E	1100
F	1101

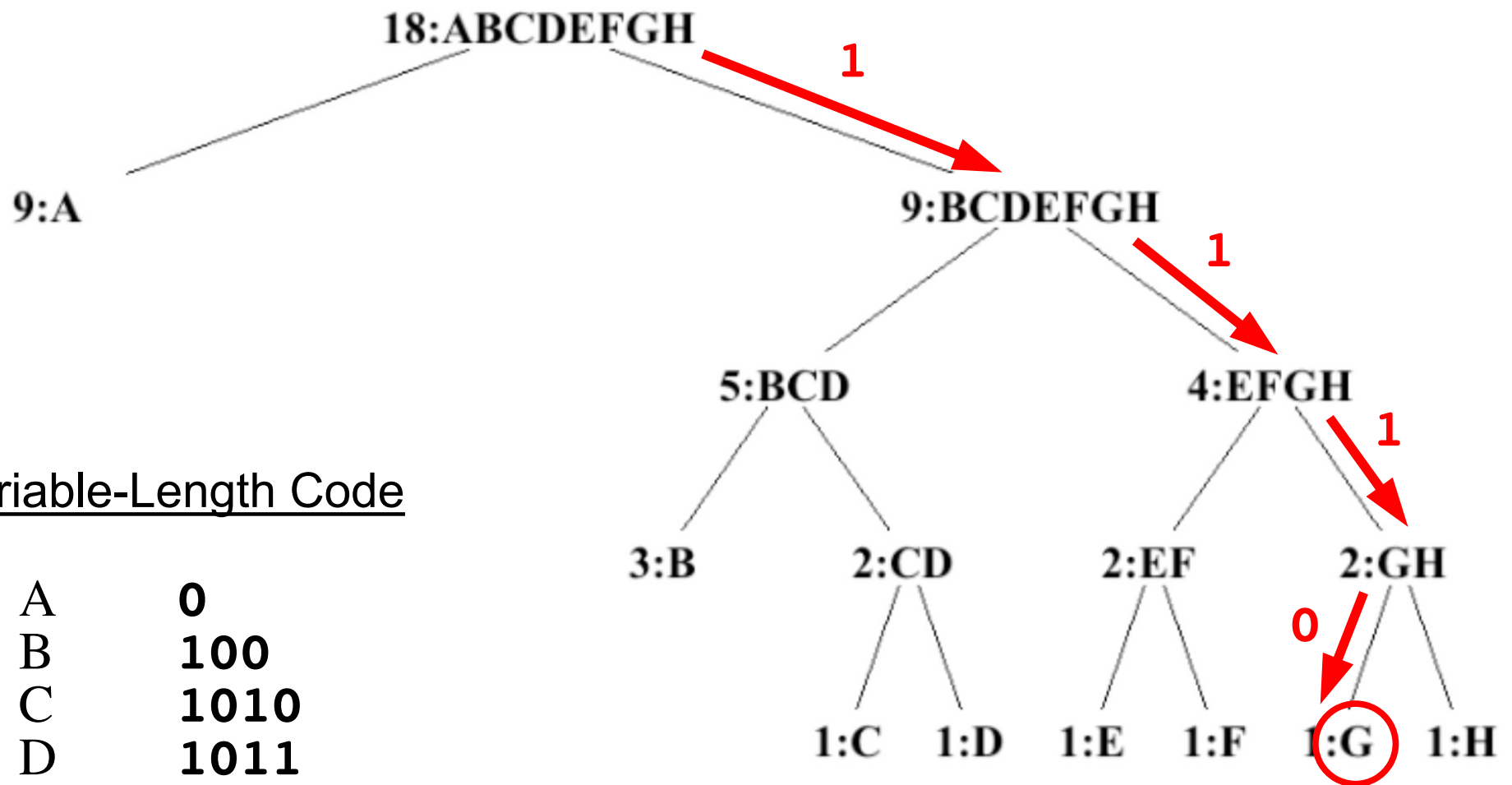

Variable-Length Code

A	0
B	100
C	1010
D	1011
E	1100
F	1101
G	1110

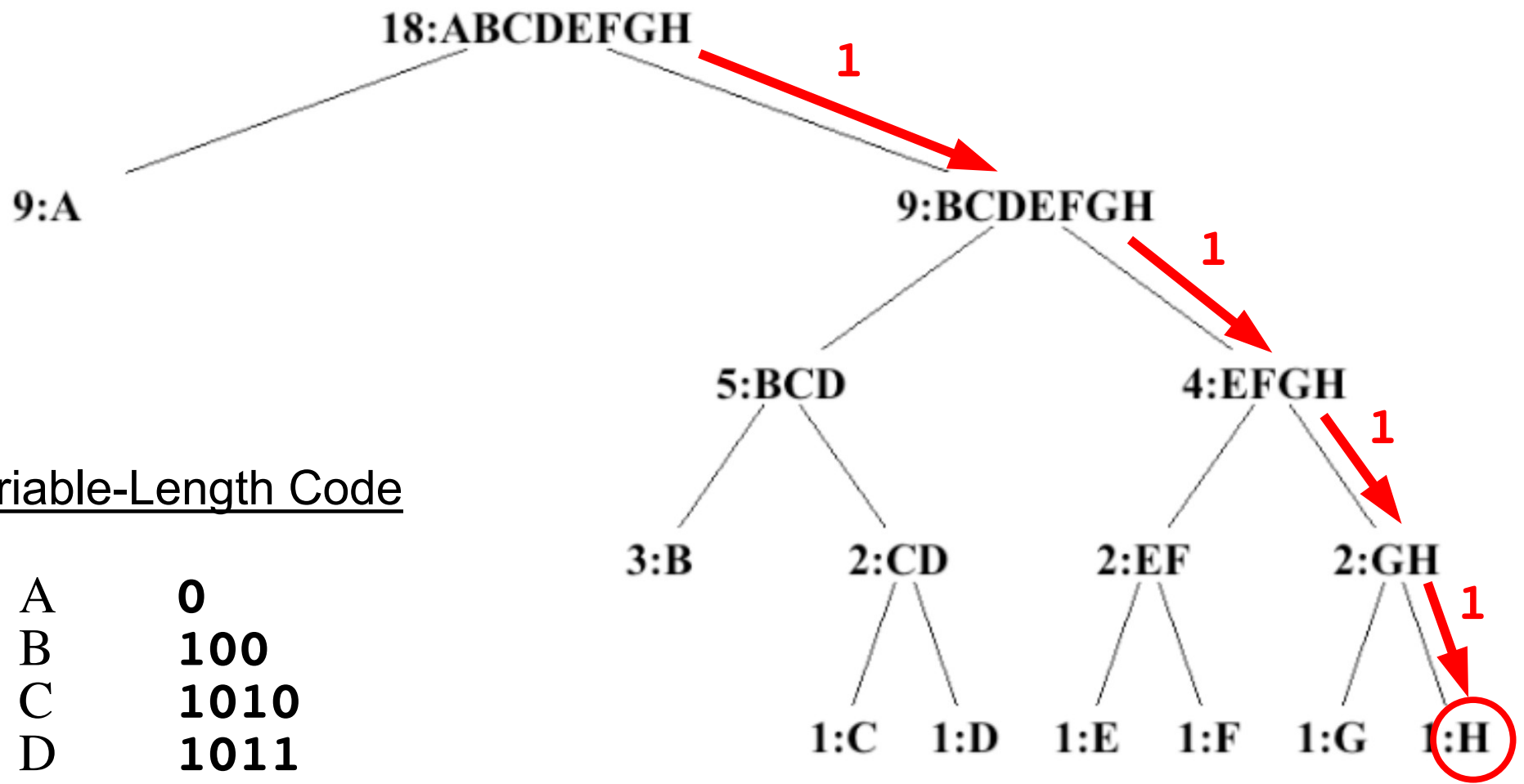

Variable-Length Code

A	0
B	100
C	1010
D	1011
E	1100
F	1101
G	1110
H	1111

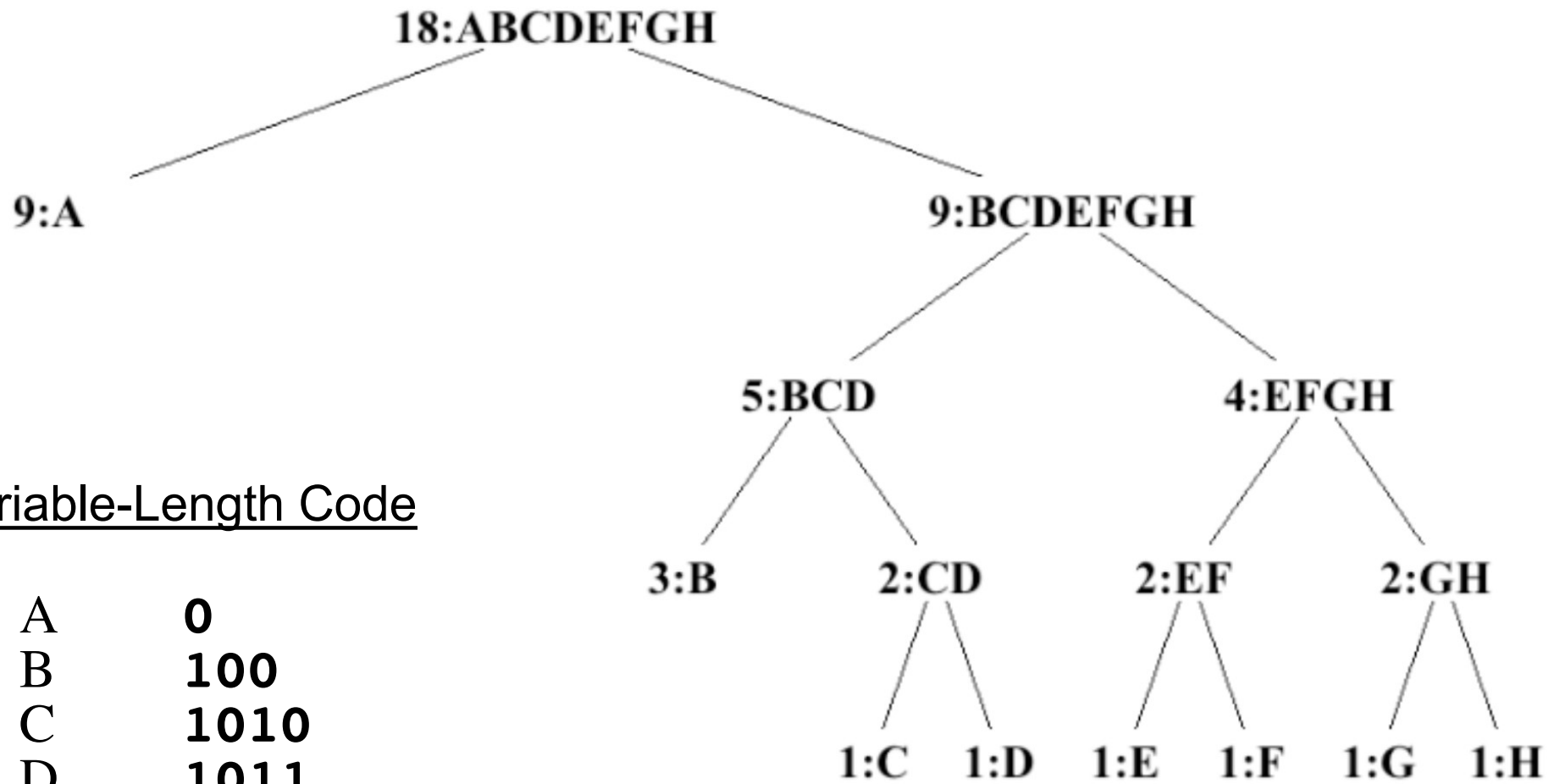

Variable-Length Code

A	0
B	100
C	1010
D	1011
E	1100
F	1101
G	1110
H	1111

B

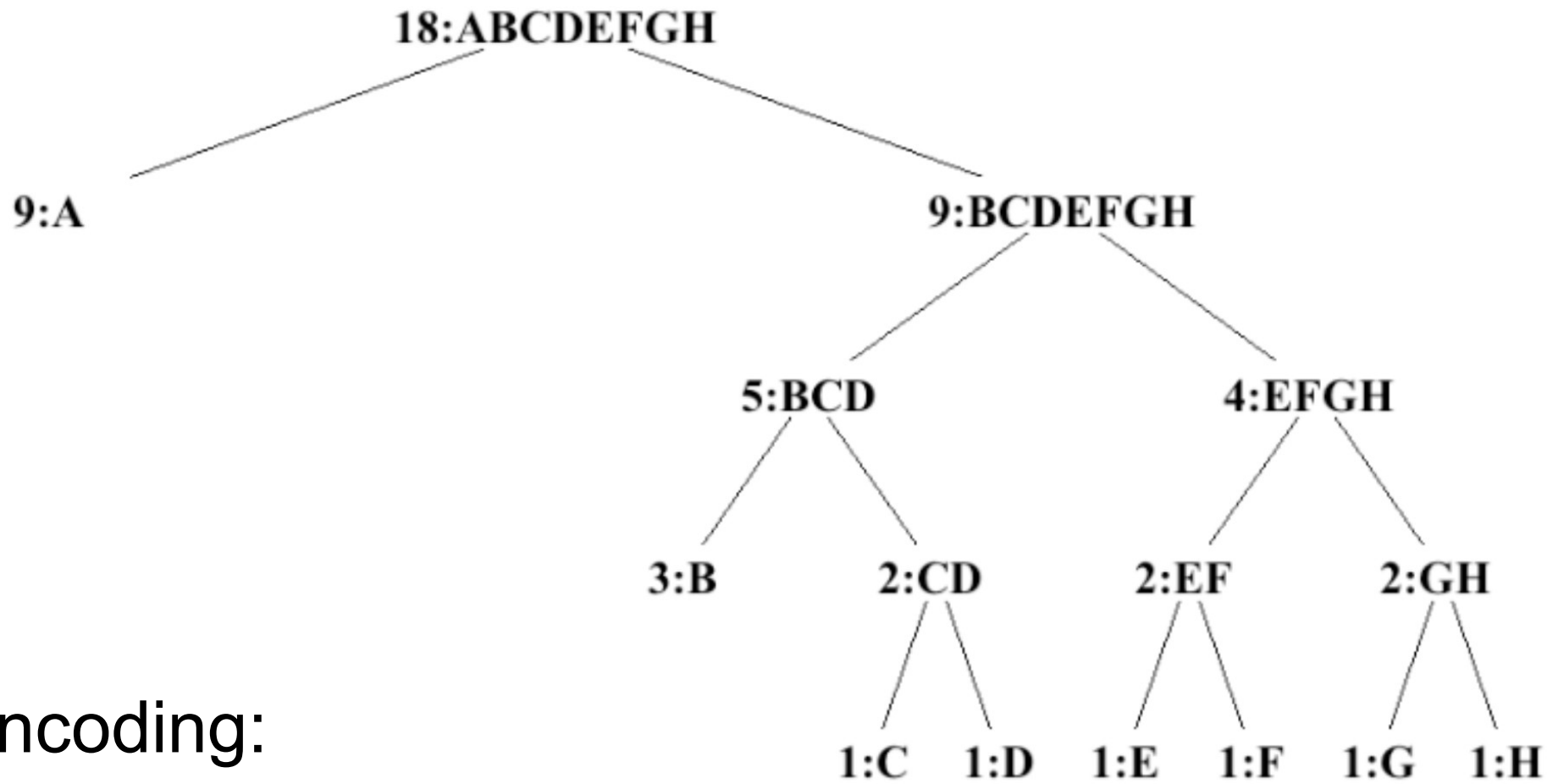

Encoding:

BA C A D A E A F A B B A A A G A H

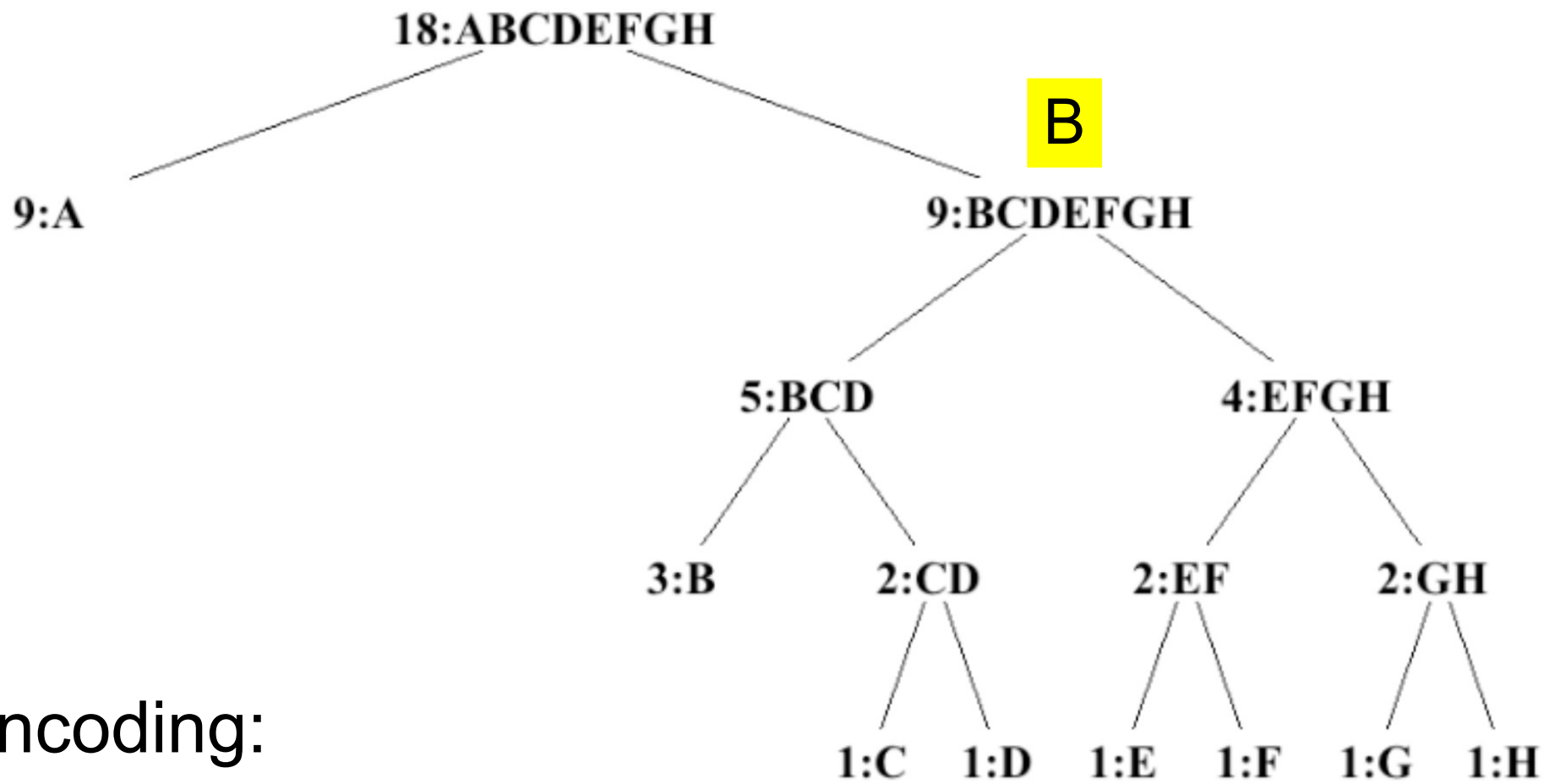

Encoding:

BA C A D A E A F A B B A A A G A H

1

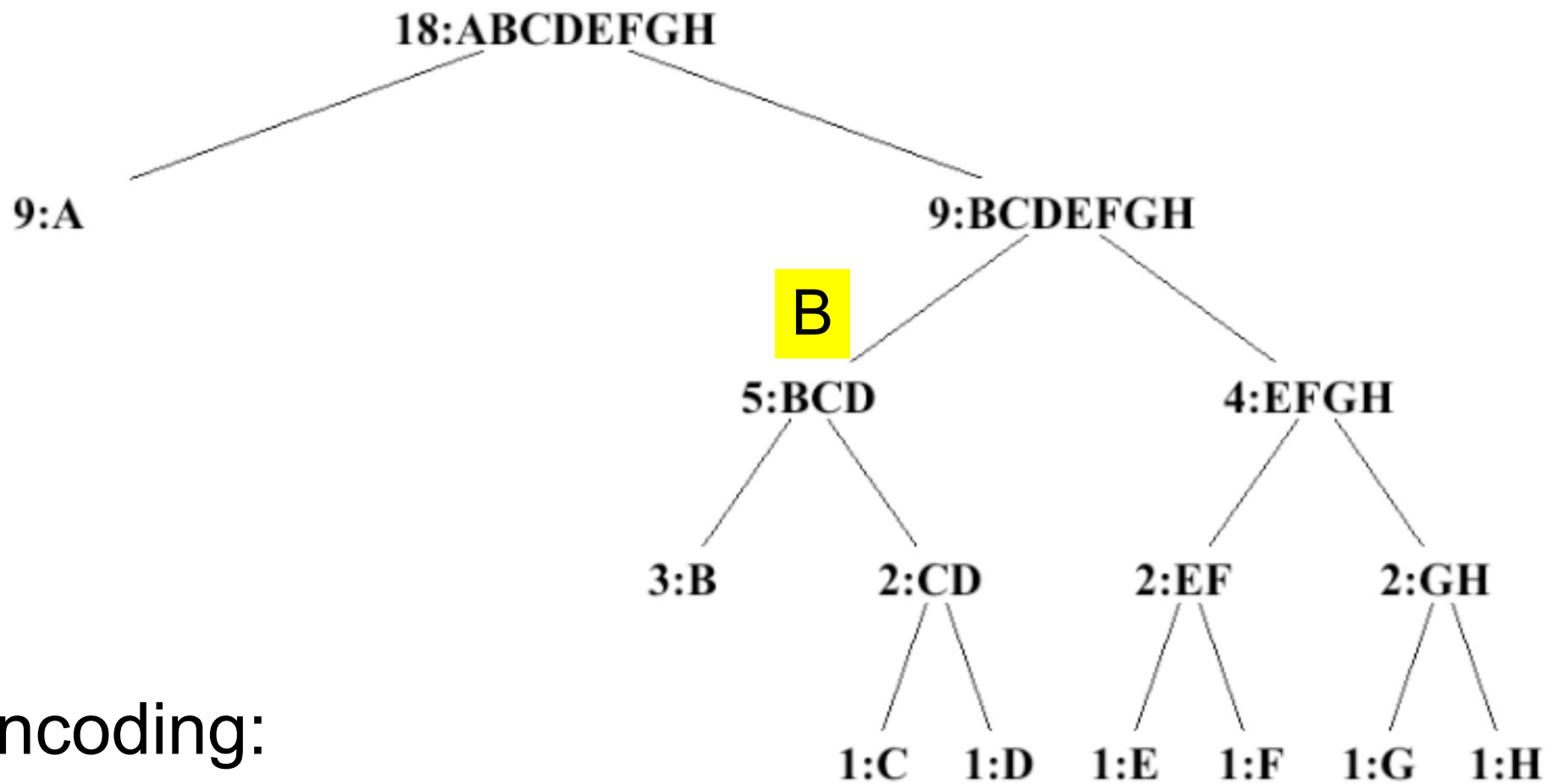

Encoding:

BA C A D A E A F A B B A A A G A H

10

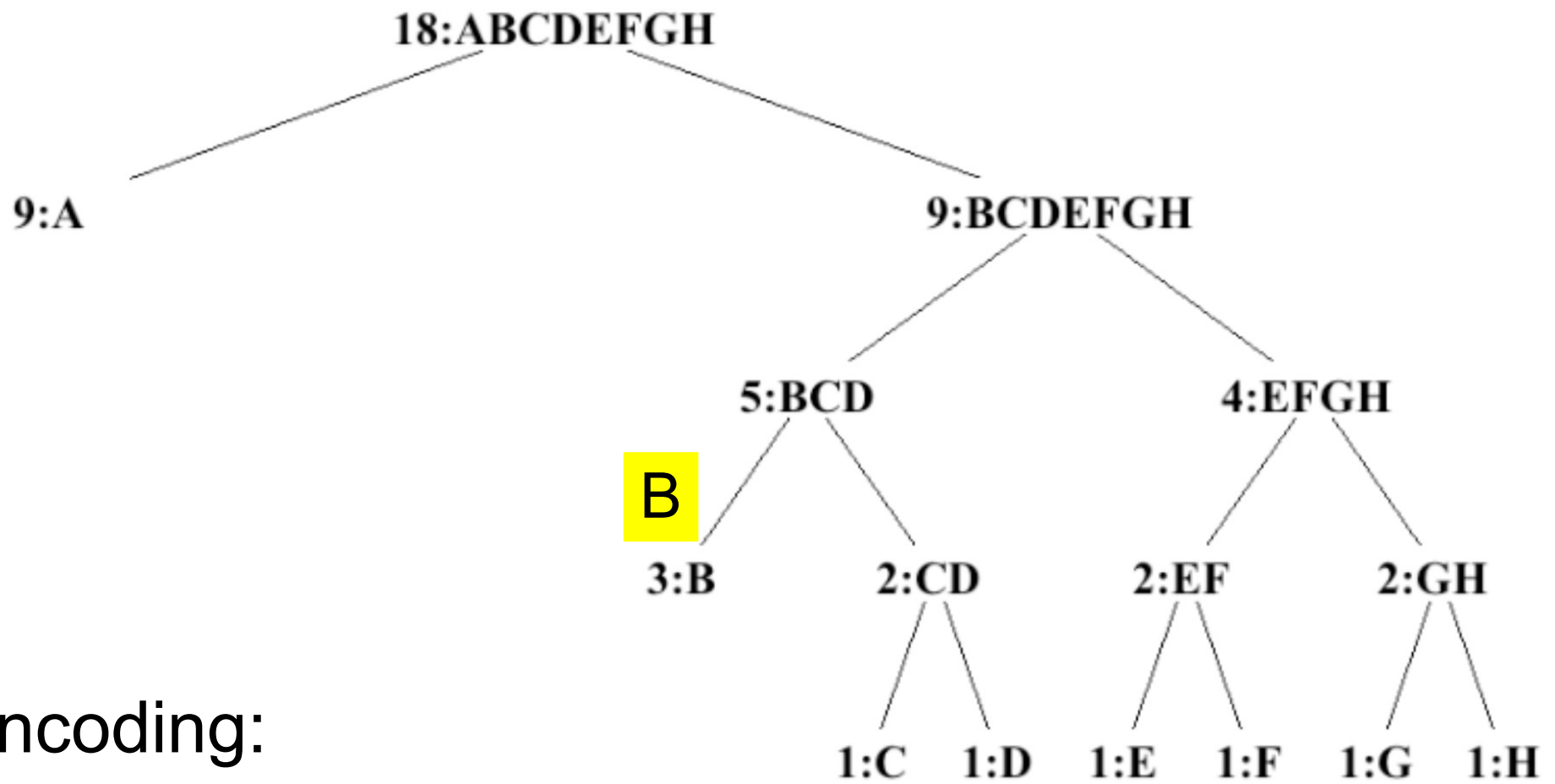

Encoding:

BA C A D A E A F A B B A A A G A H

100

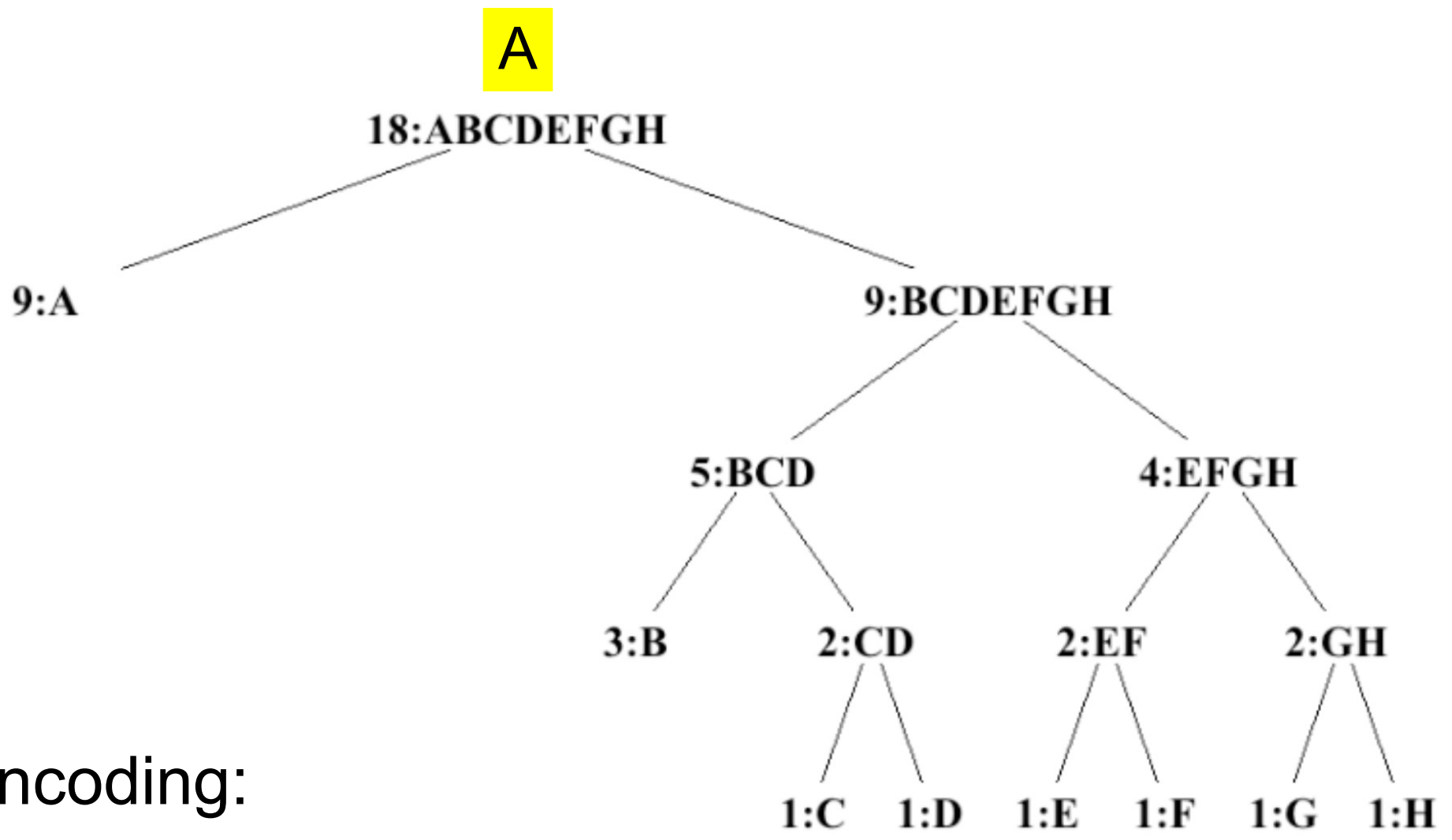

Encoding:

BACADAEAFABBAAGAH

100

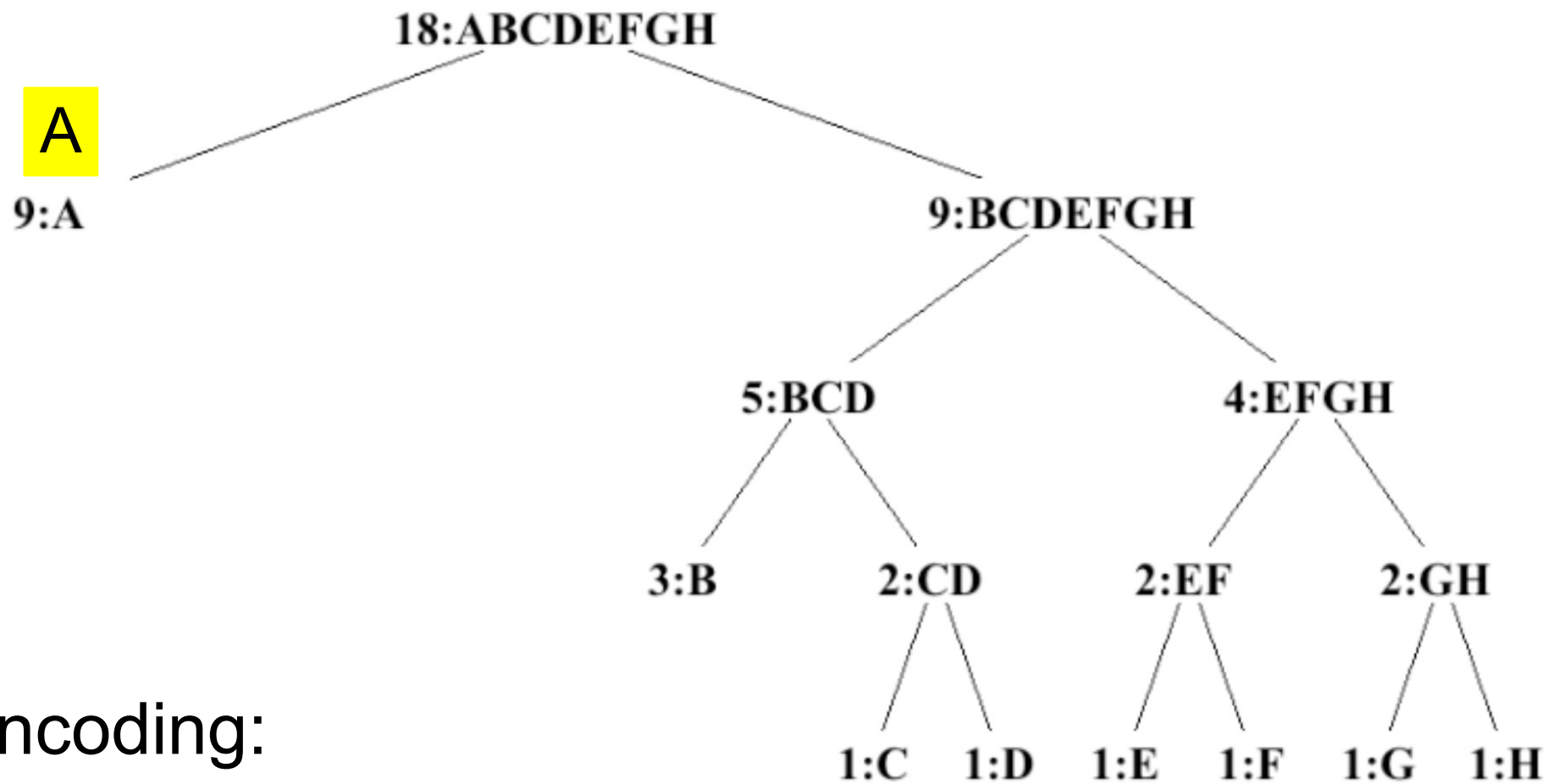

Encoding:

BACADAEAFABBAAGAH

100 0

C

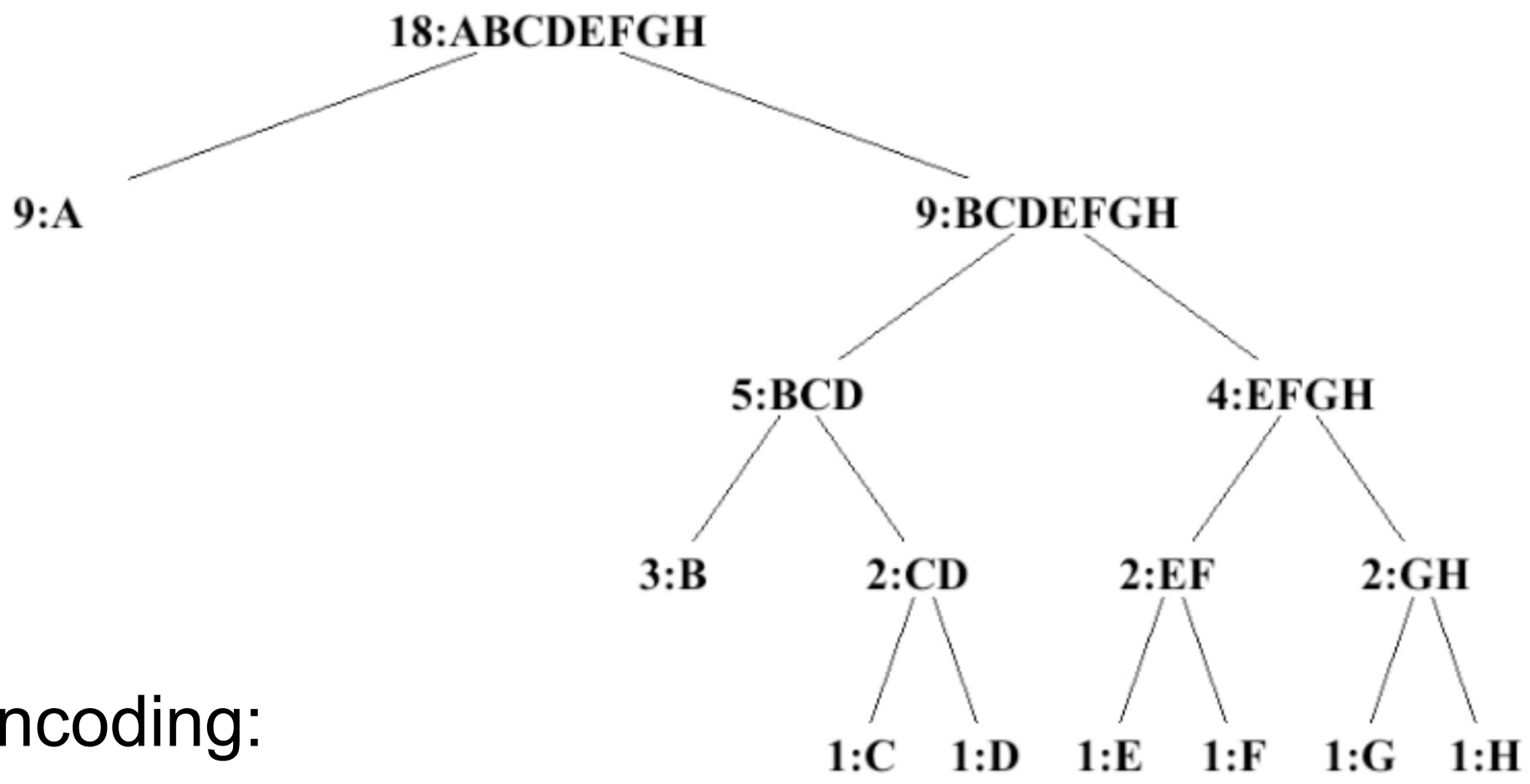

Encoding:

BACADAEAFABBAAGAH

100 0

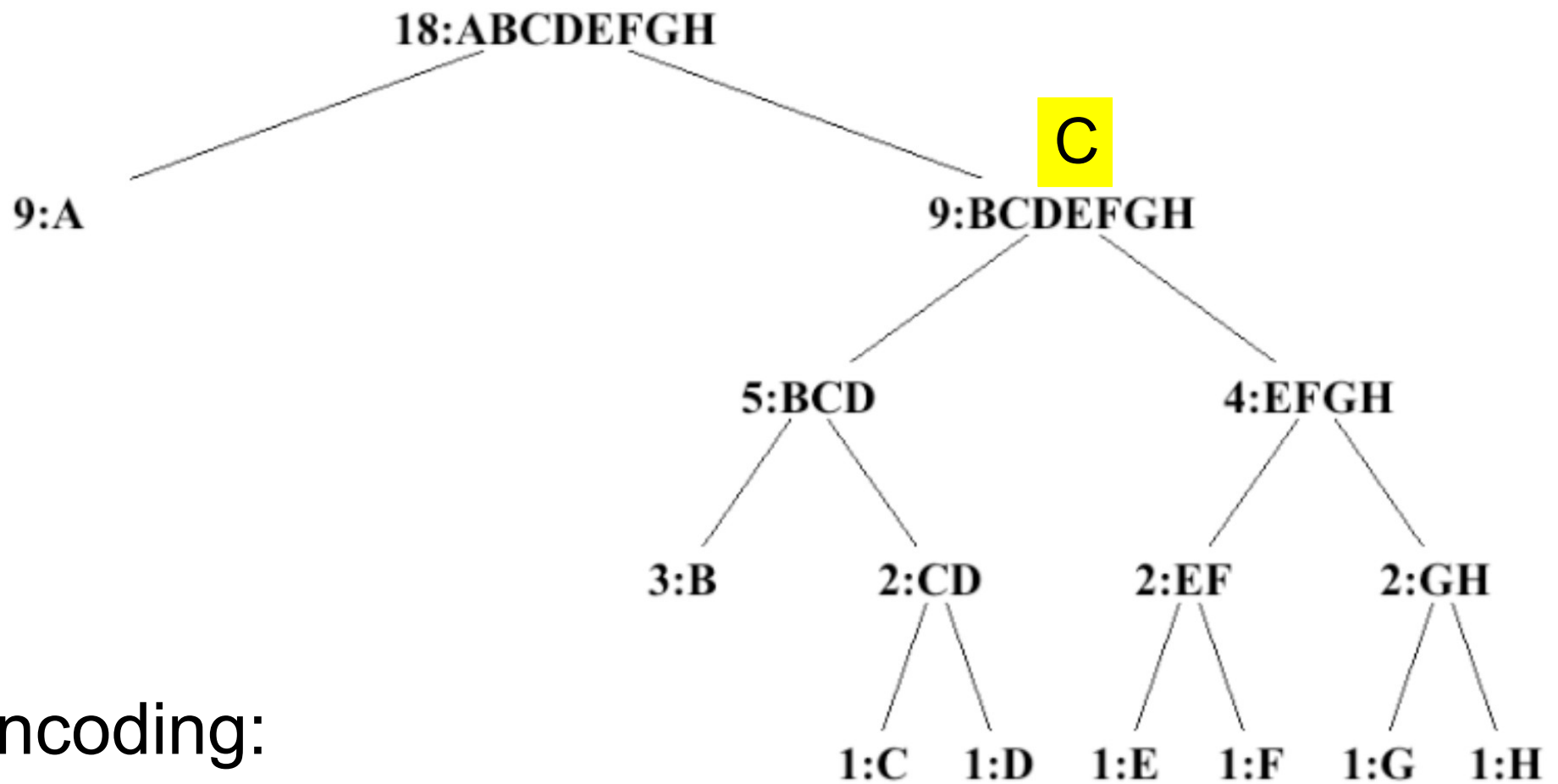

Encoding:

BACADAEAFABBAAGAH

100 0 1

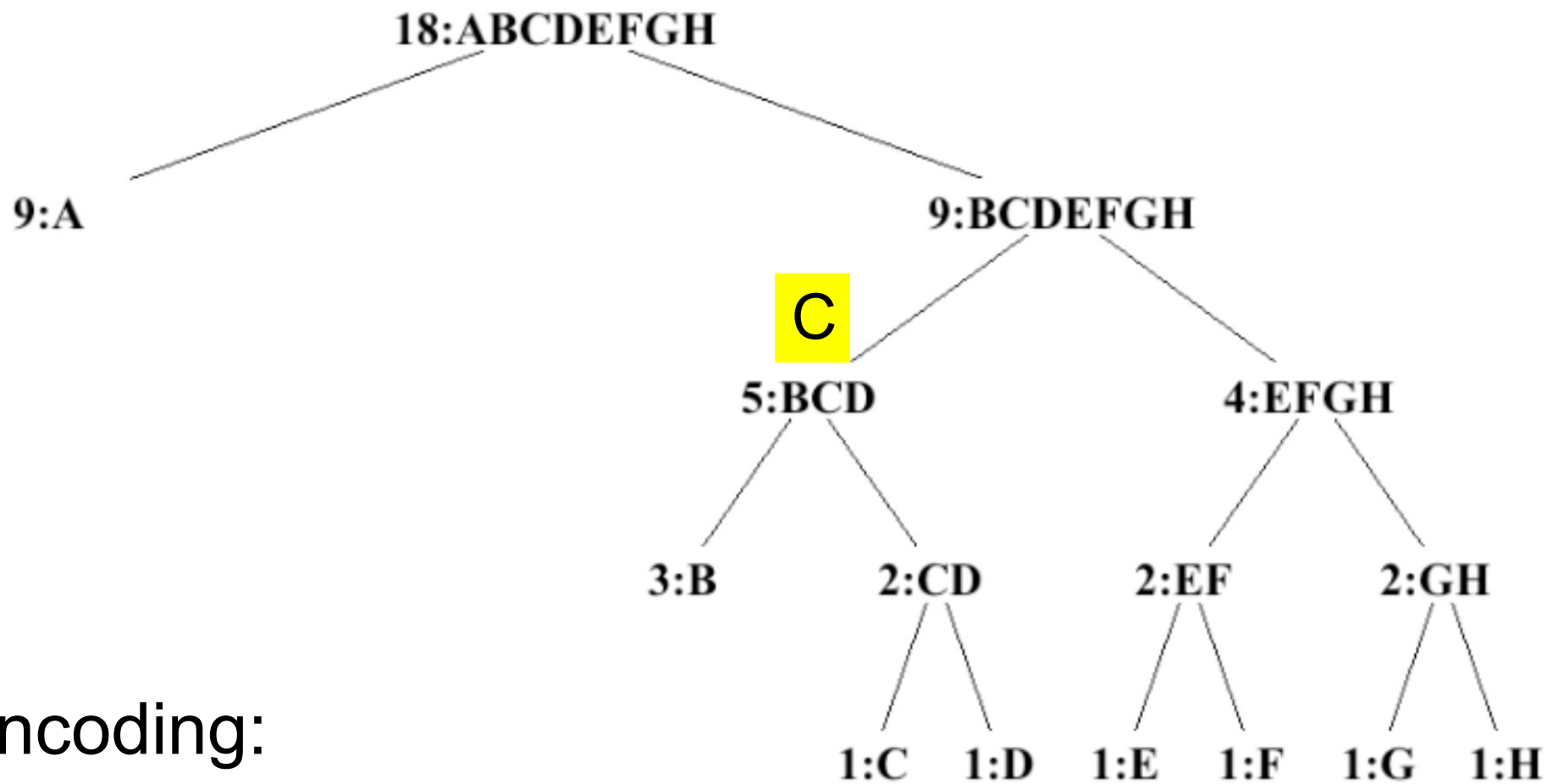

Encoding:

BACADAEAFABBAAGAH

100 0 10

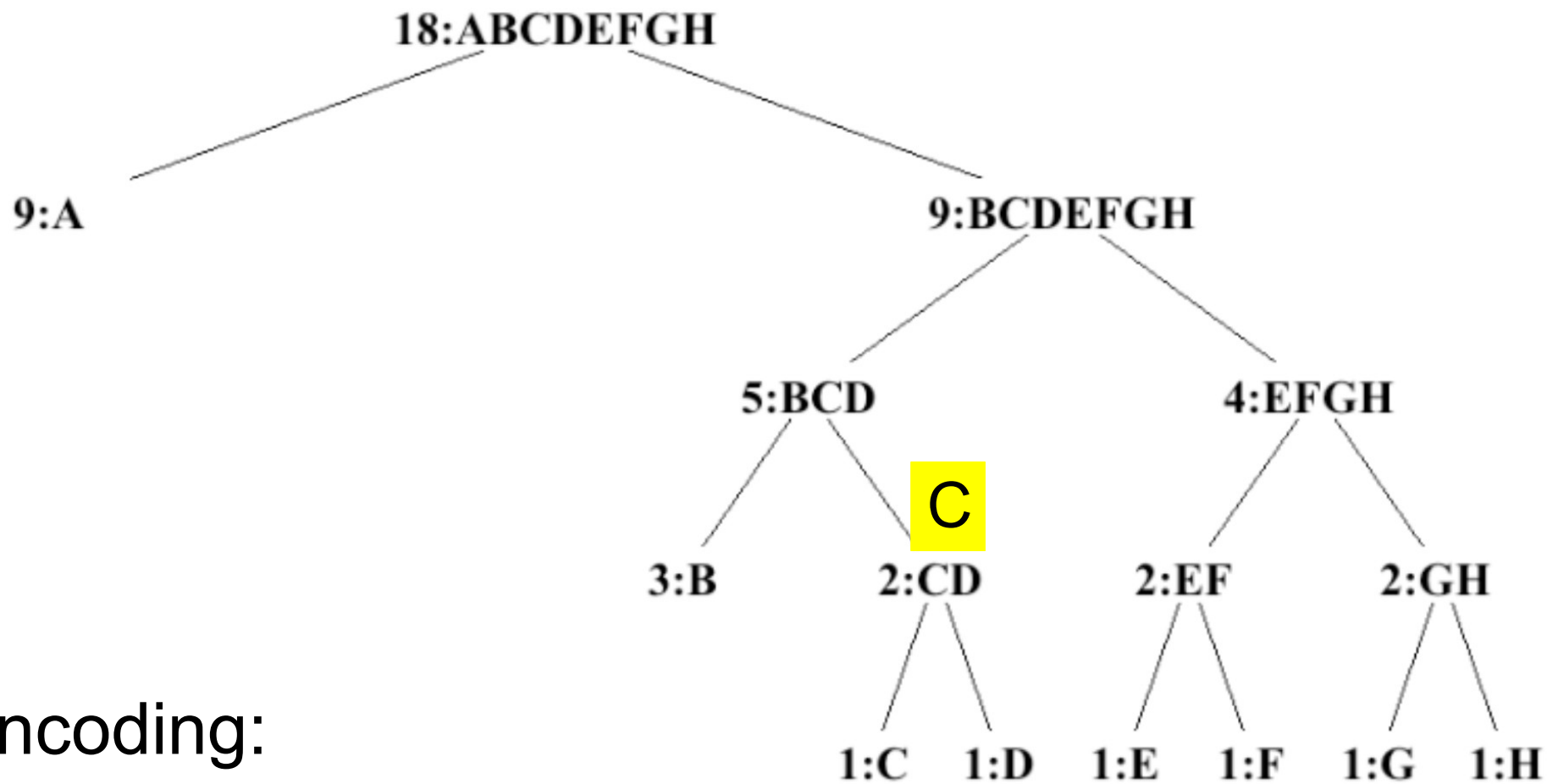

Encoding:

BACADAEAFABBAAGAH

100 0 101

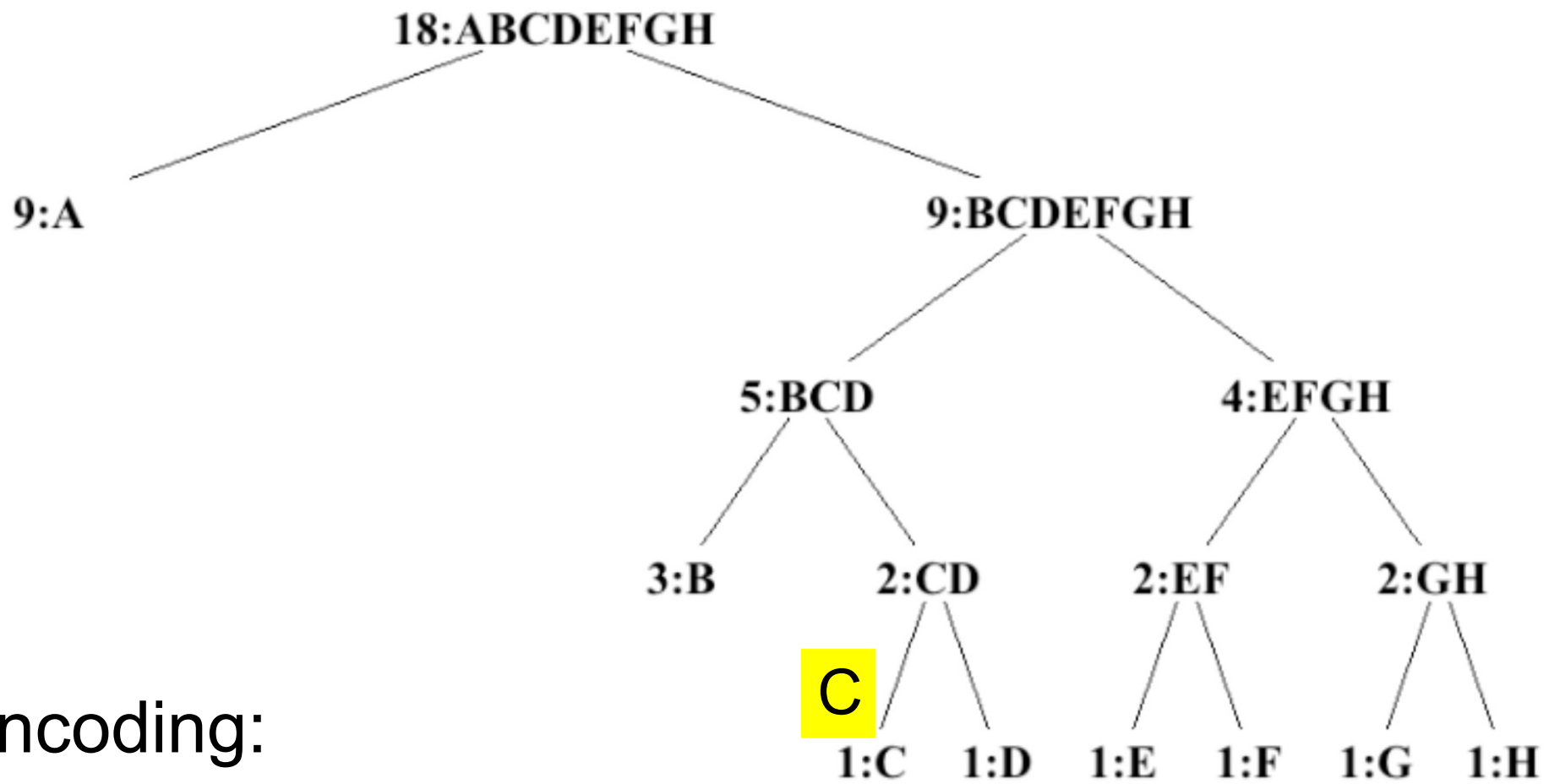

Encoding:

BACADAEAFABBAAGAH

100 0 1010

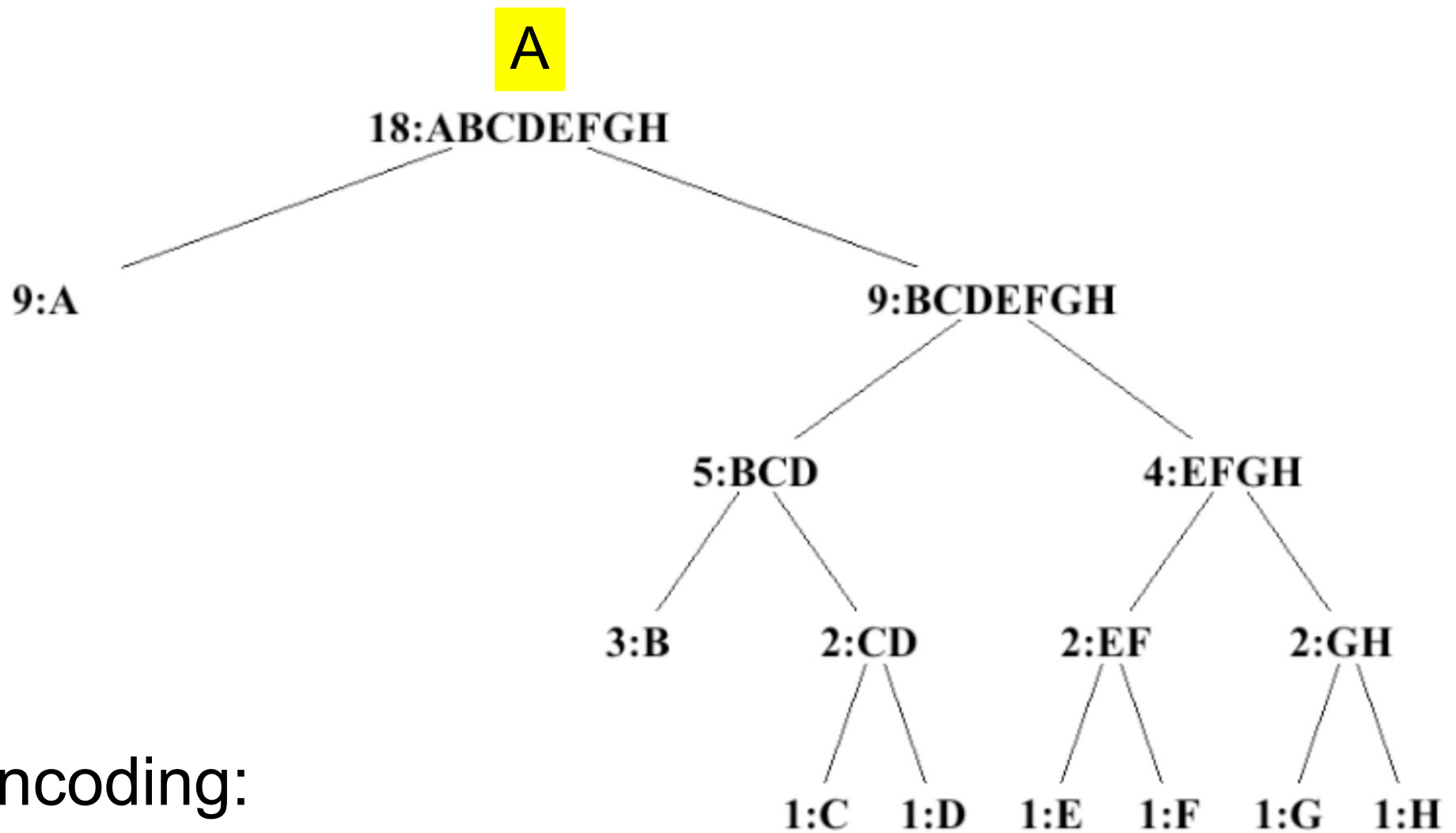

Encoding:

BACADAEAFABBAAGAH

100 0 1010

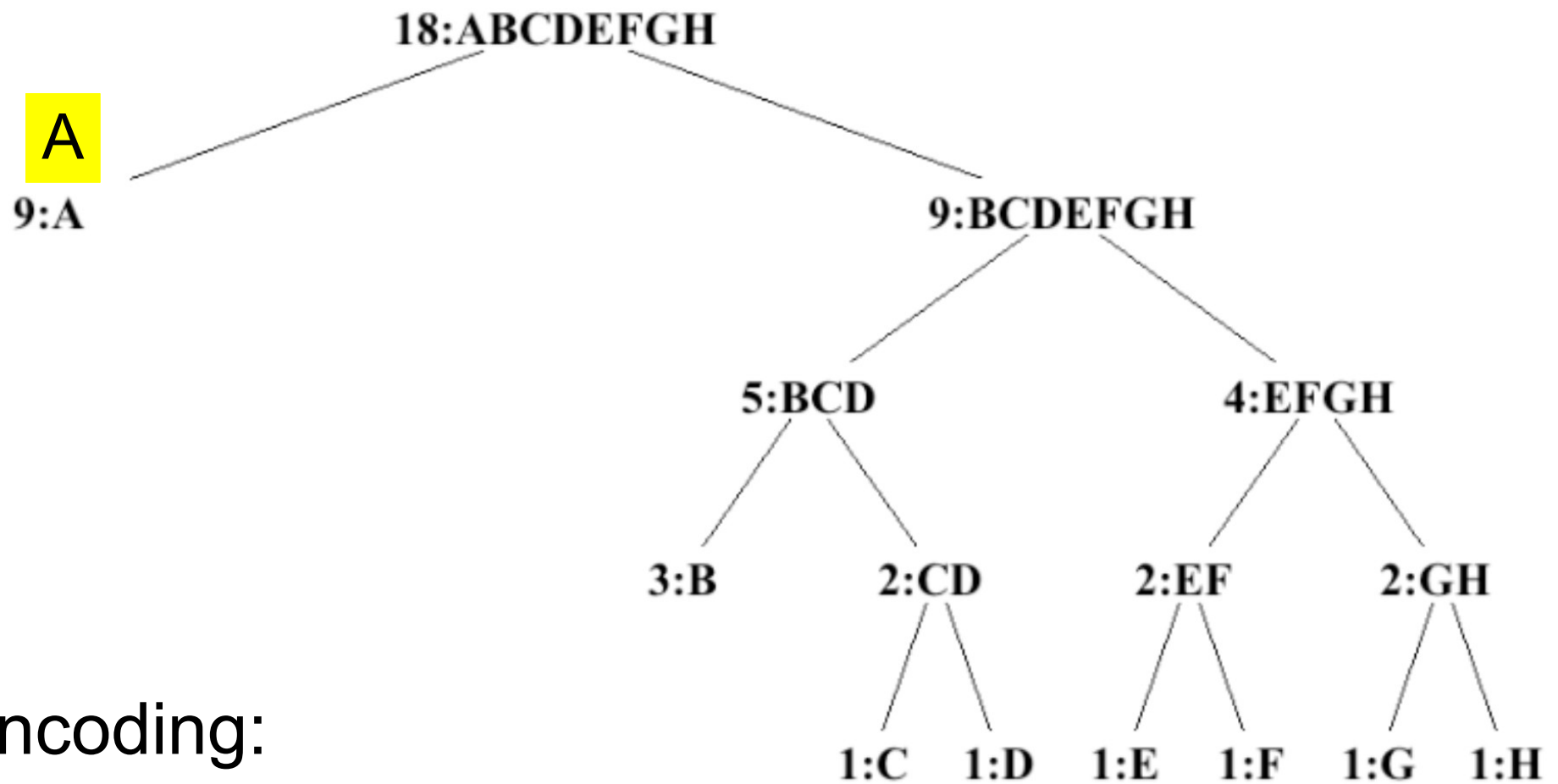

Encoding:

BACADAEAFABBAAGAH

100 0 1010 0

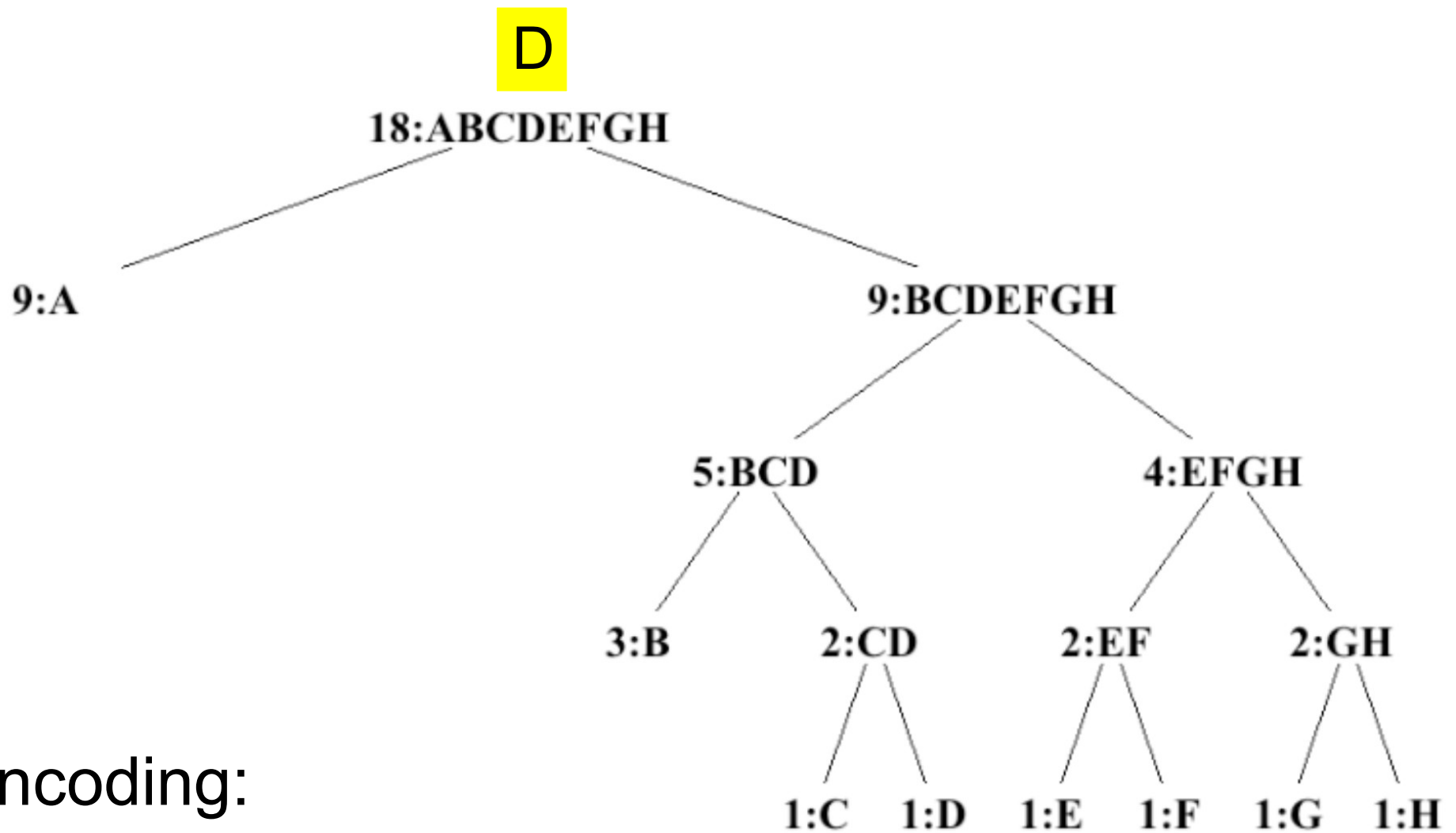

Encoding:

BACADAEAFABBAAGAH

100 0 1010 0

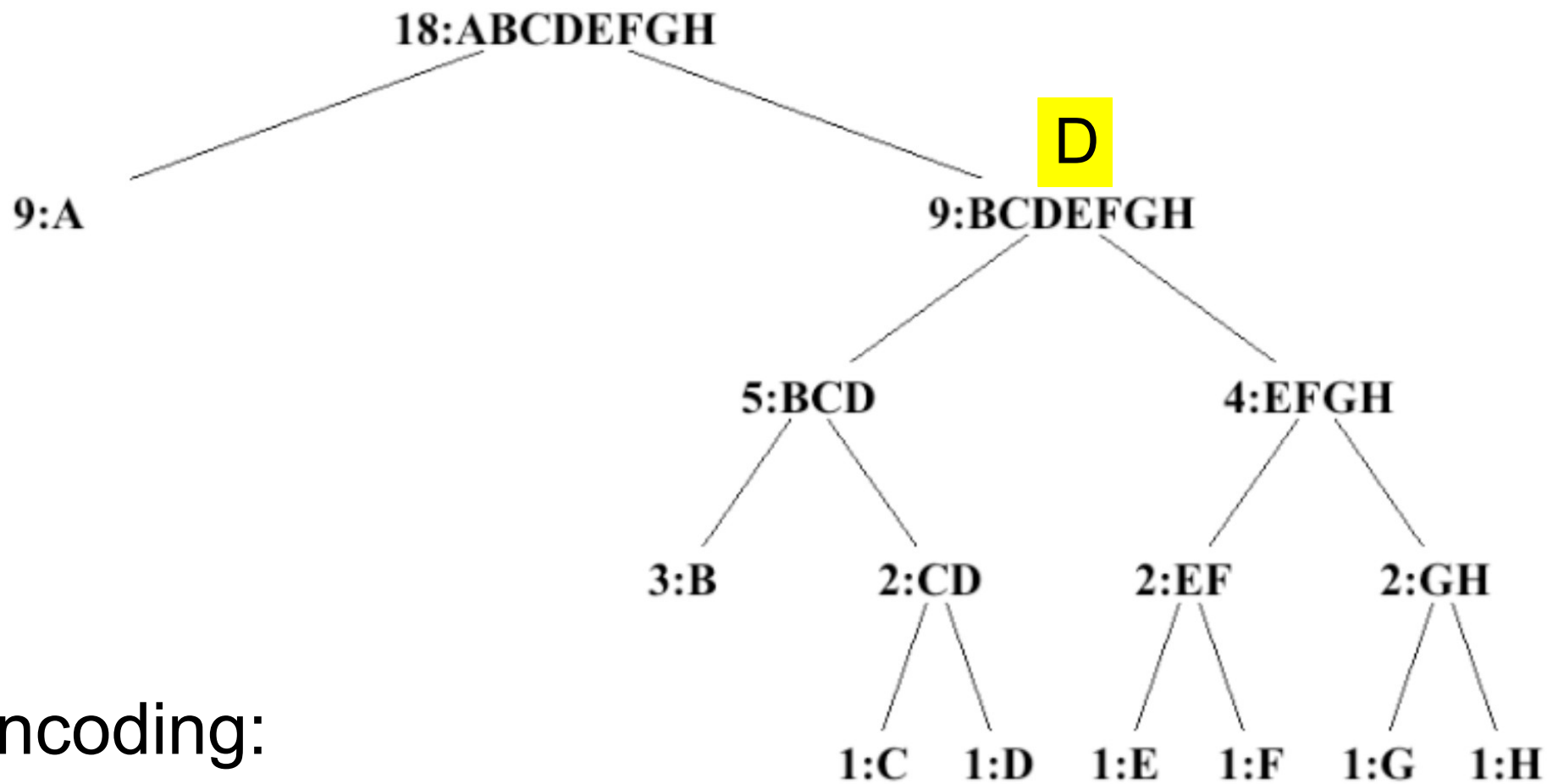

Encoding:

BACADAEAFABBAAGAH

100 0 1010 0 1

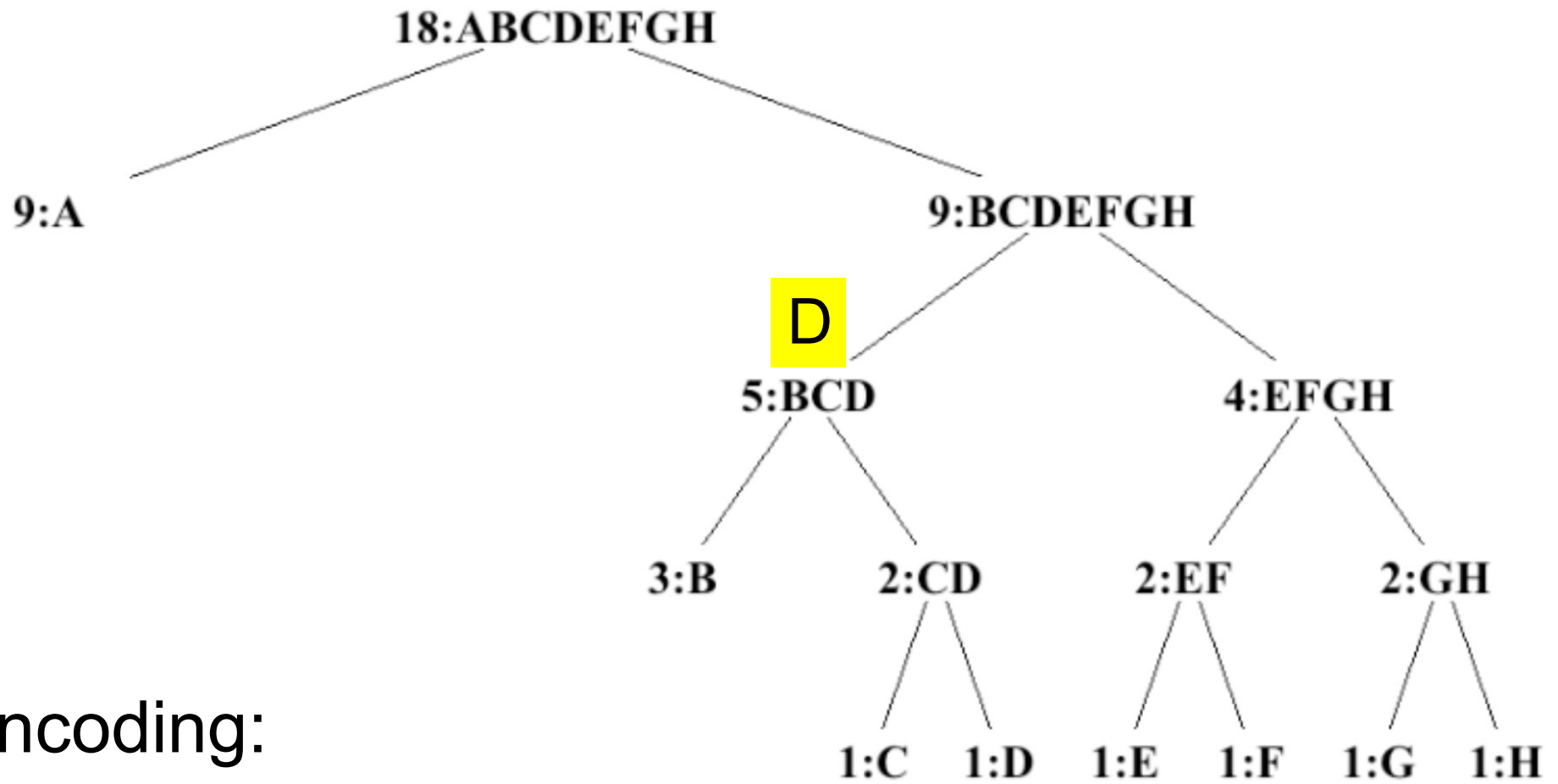

Encoding:

BACADAEAFABBAAGAH

100 0 1010 0 10

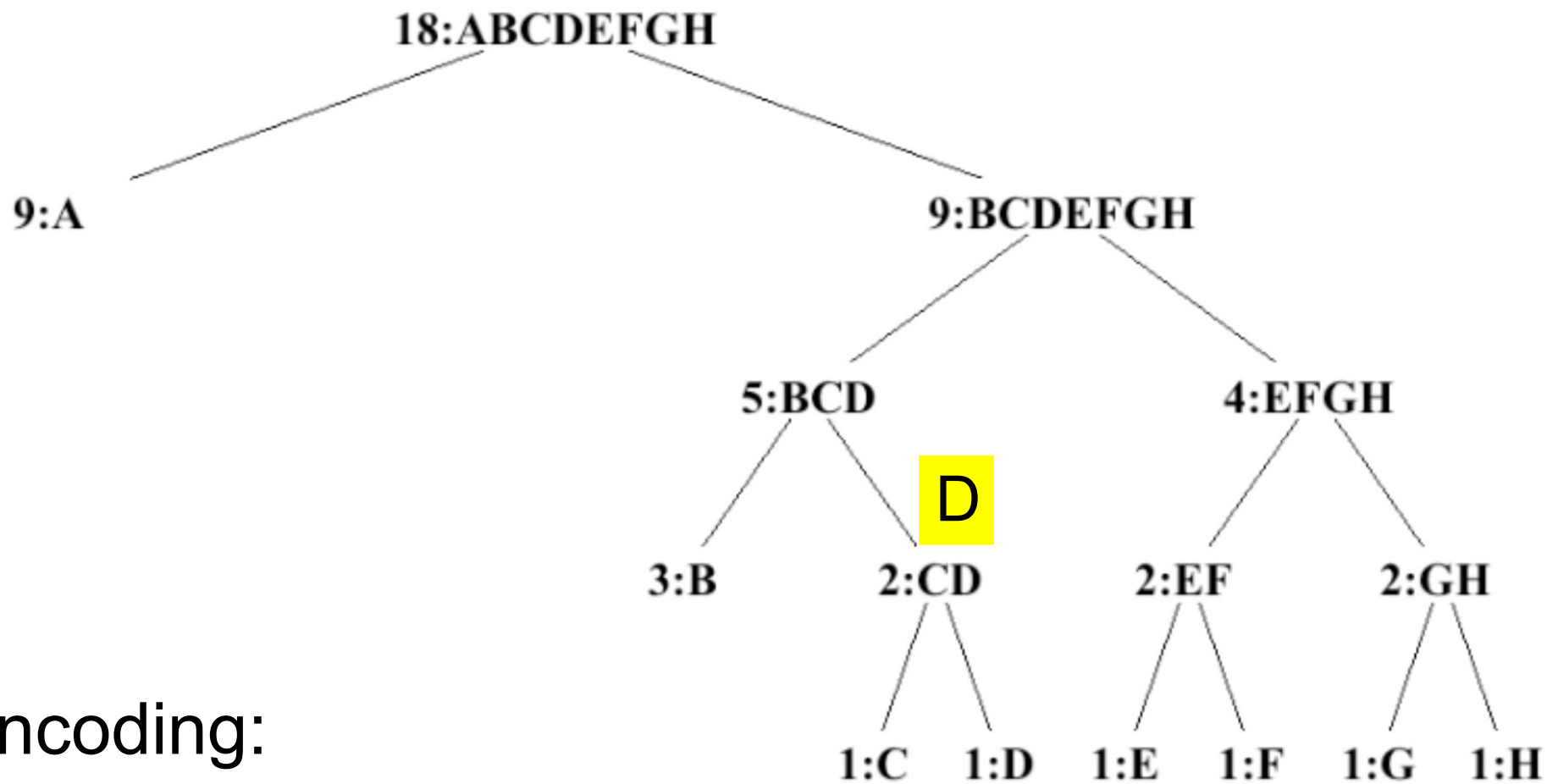

Encoding:

BACADAEAFABBAAGAH

100 0 1010 0 101

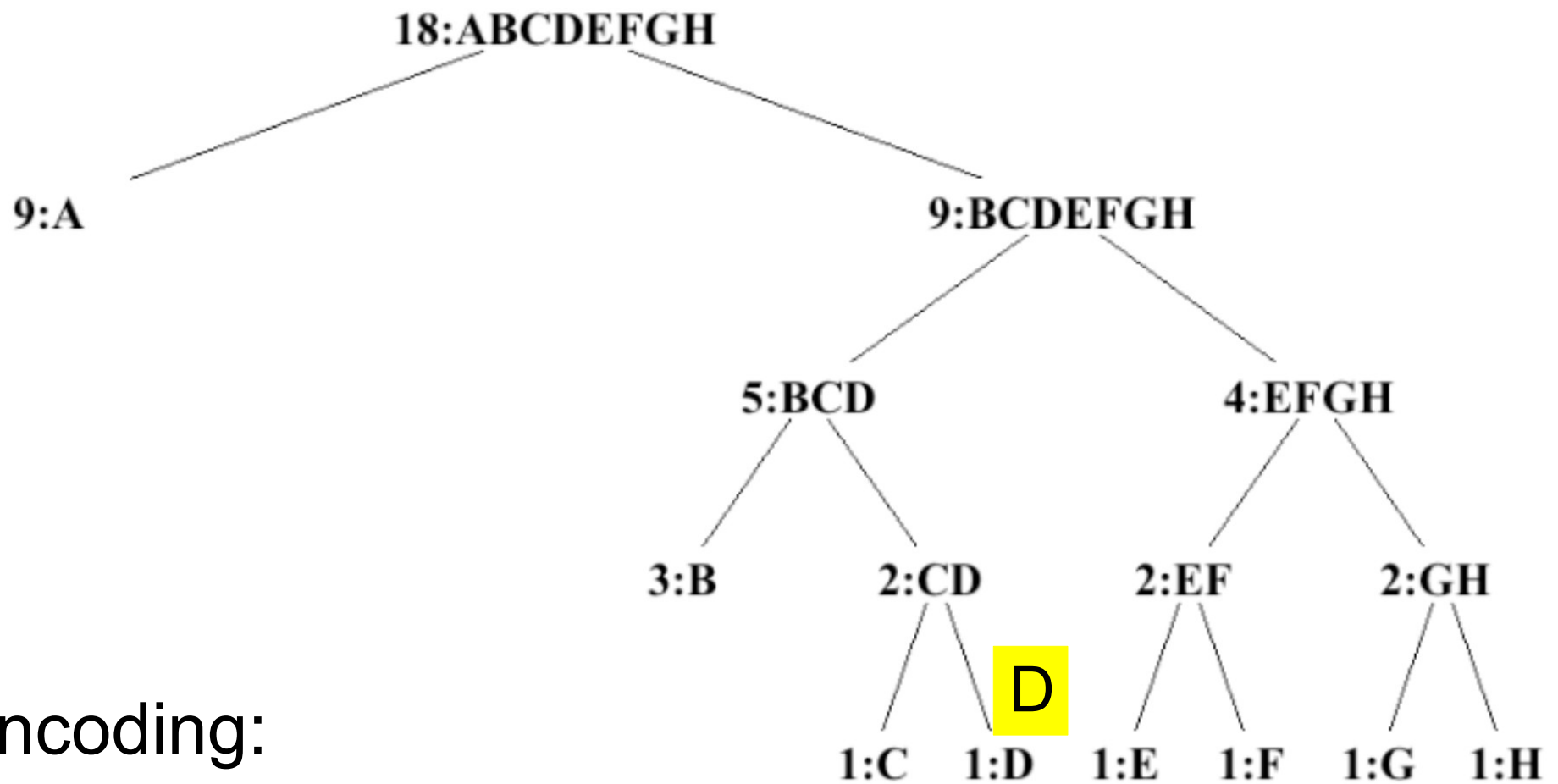

Encoding:

BACADAEAFABBAAGAH

100 0 1010 0 1011

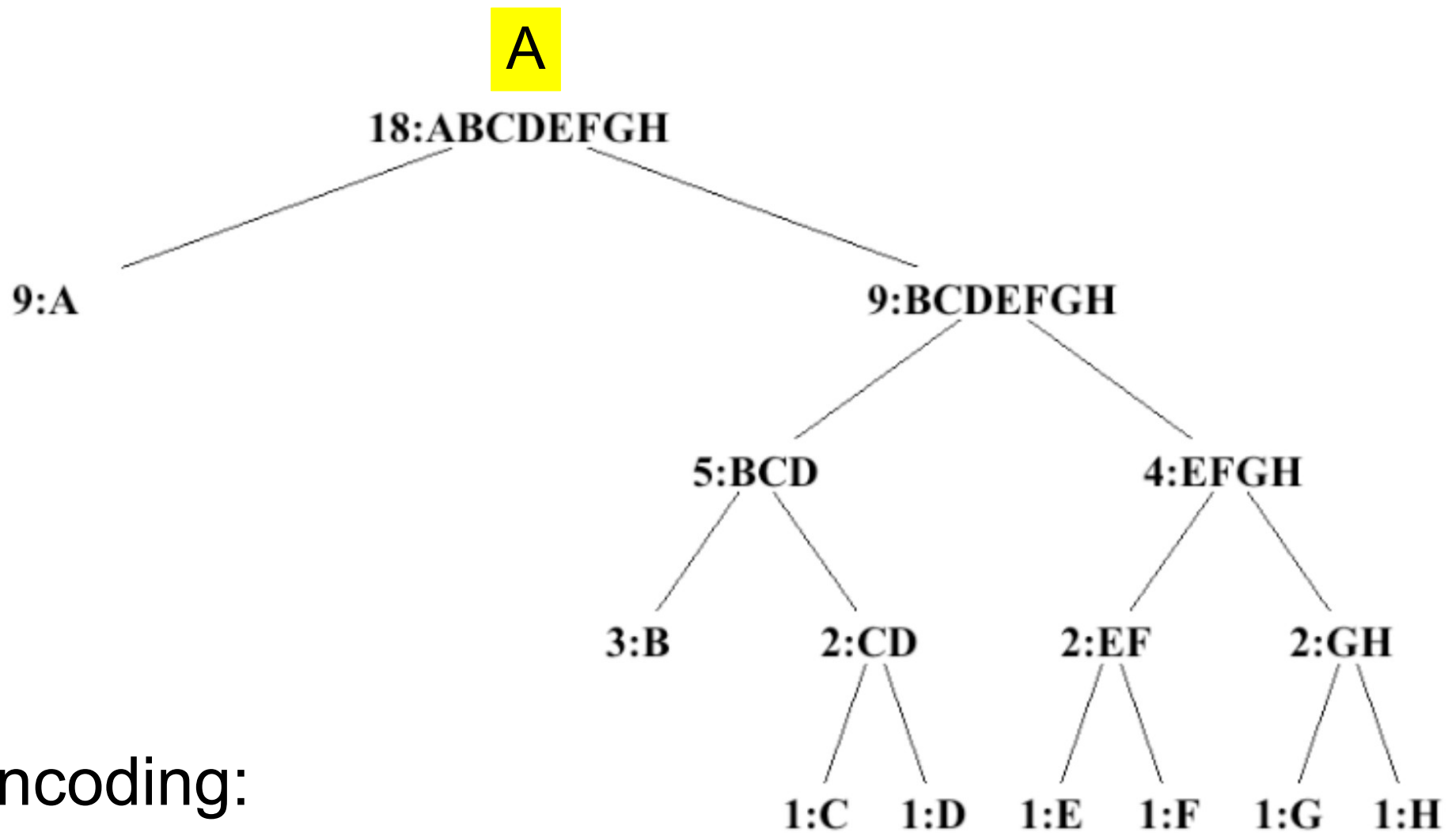

Encoding:

BACAD**A**EAFABBAAGAH

100 0 1010 0 1011

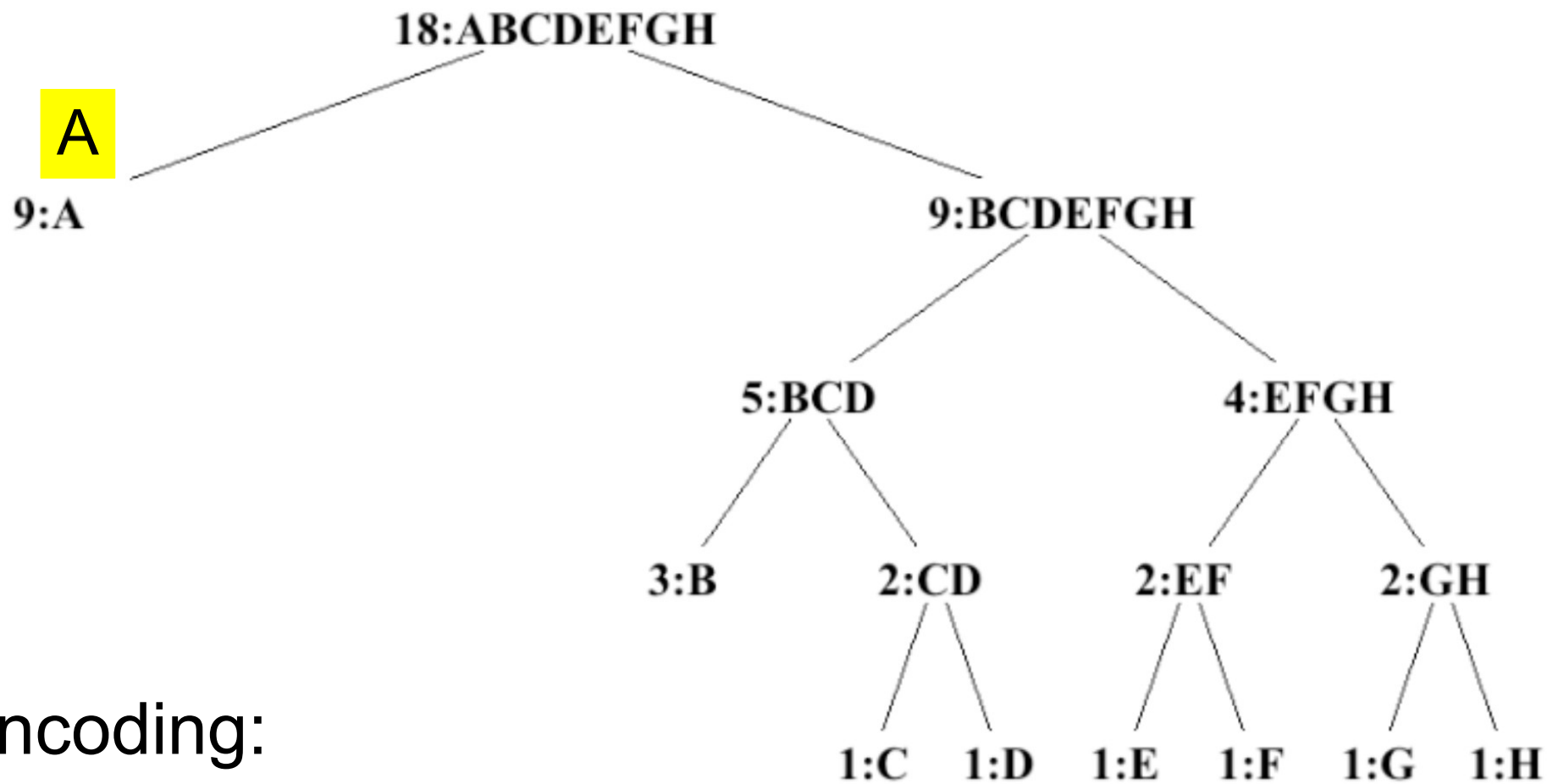

Encoding:

BACADAEAFABBAAGAH

100 0 1010 0 1011 0

E

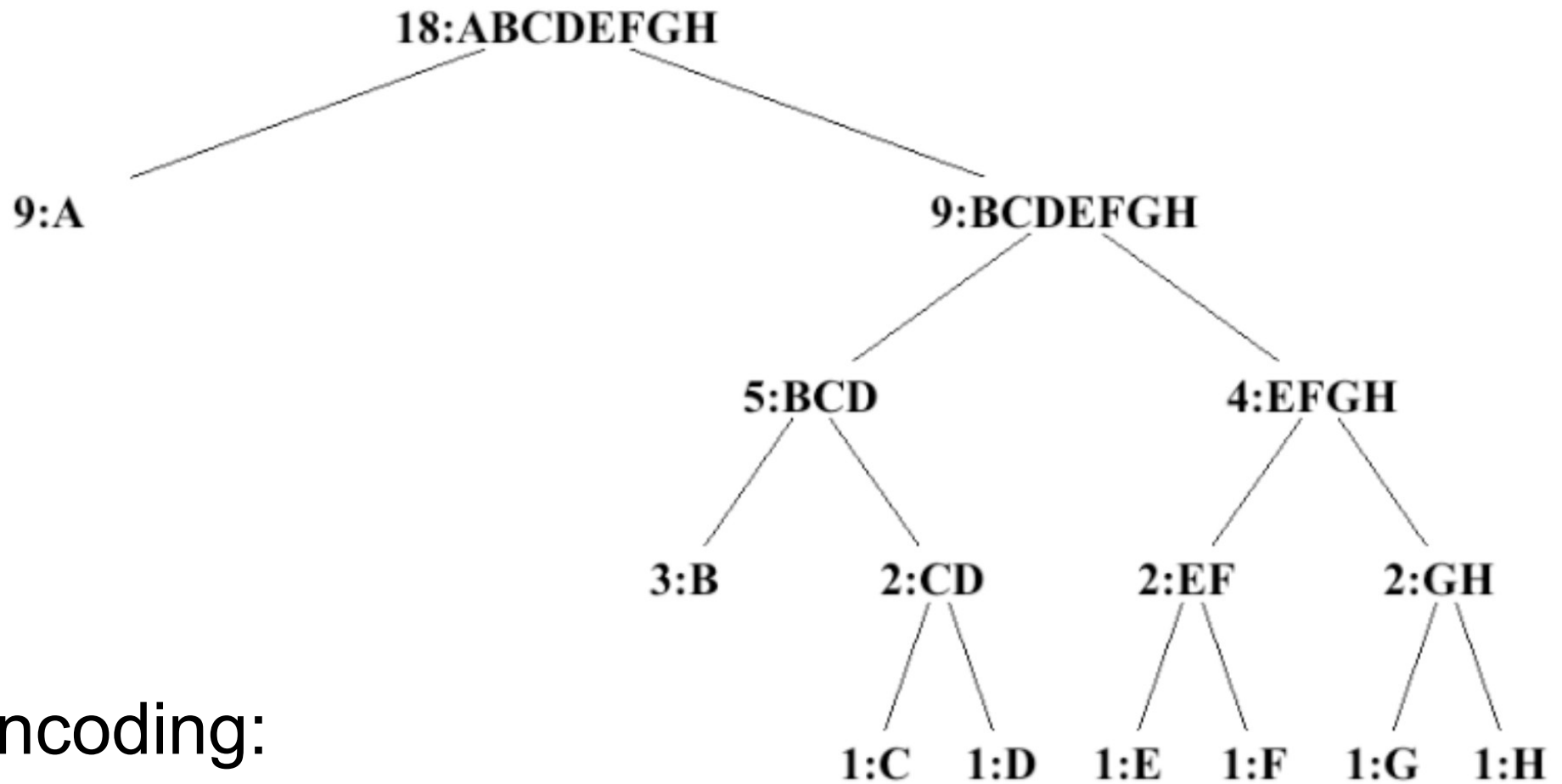

Encoding:

BACADA**E**AFABBAAGAH

100 0 1010 0 1011 0

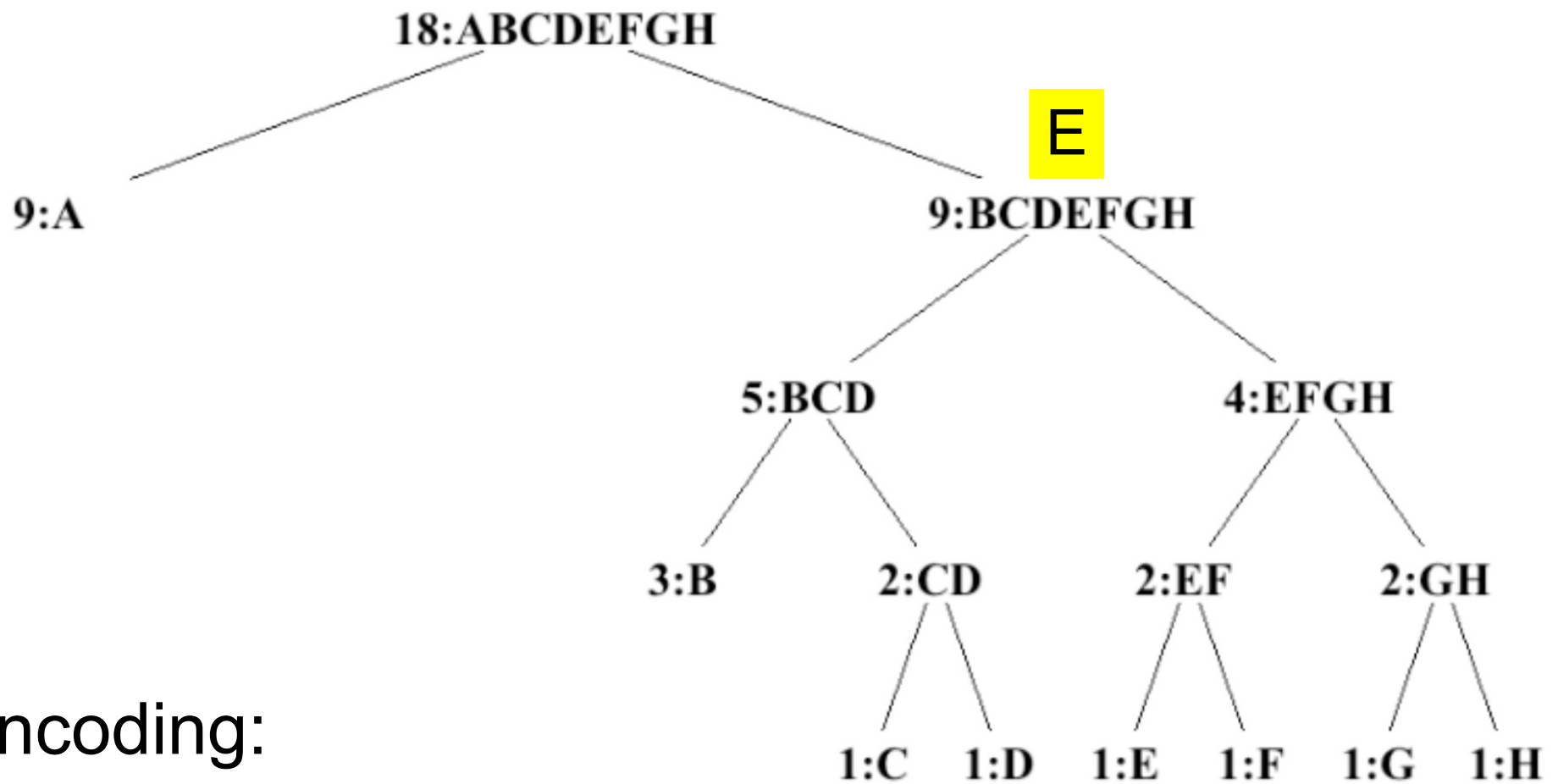

Encoding:

BACADA**E**AFABBAAGAH

100 0 1010 0 1011 0 1

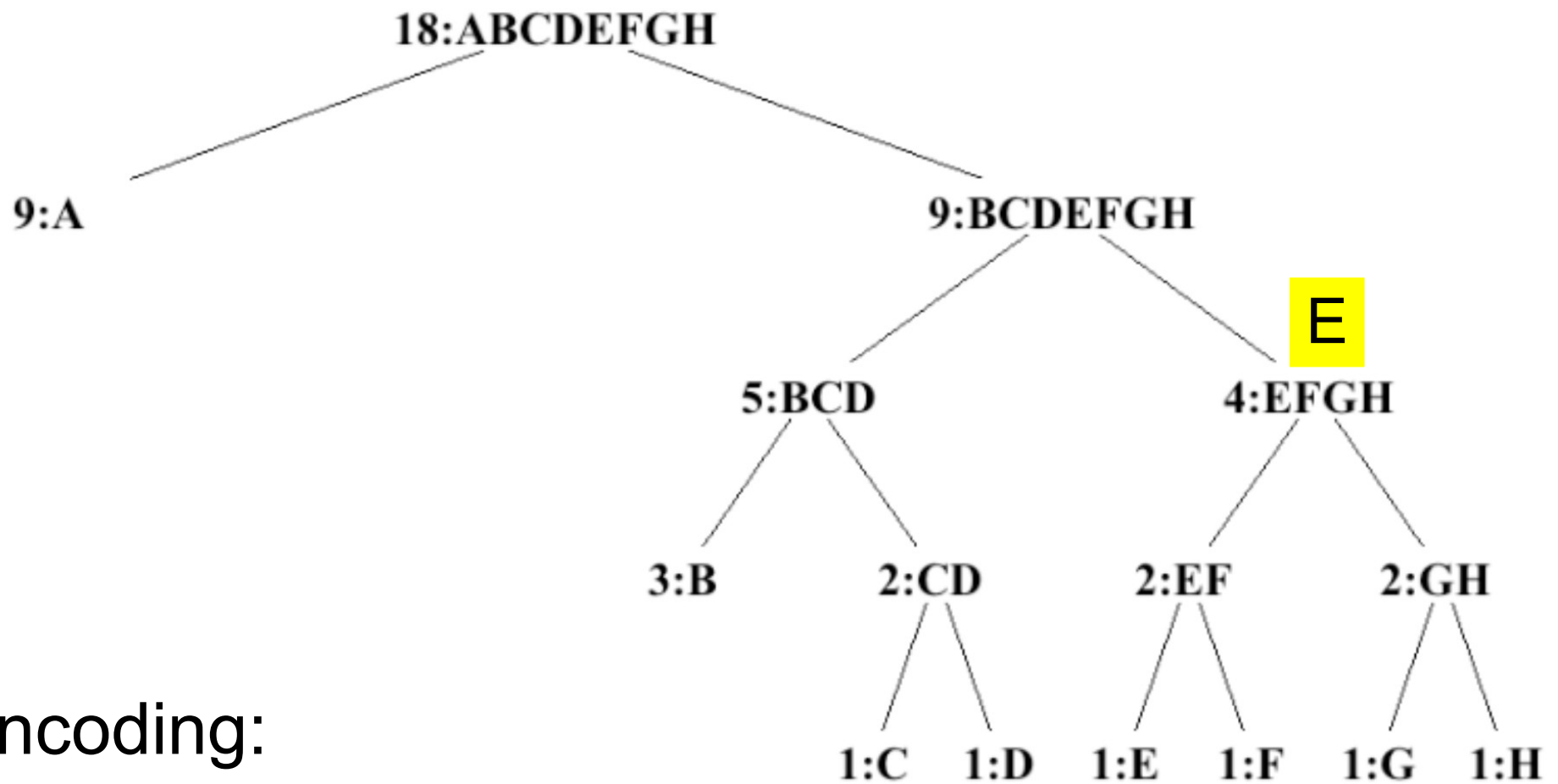

Encoding:

BACADA**E**AFABBAAGAH

100 0 1010 0 1011 0 11

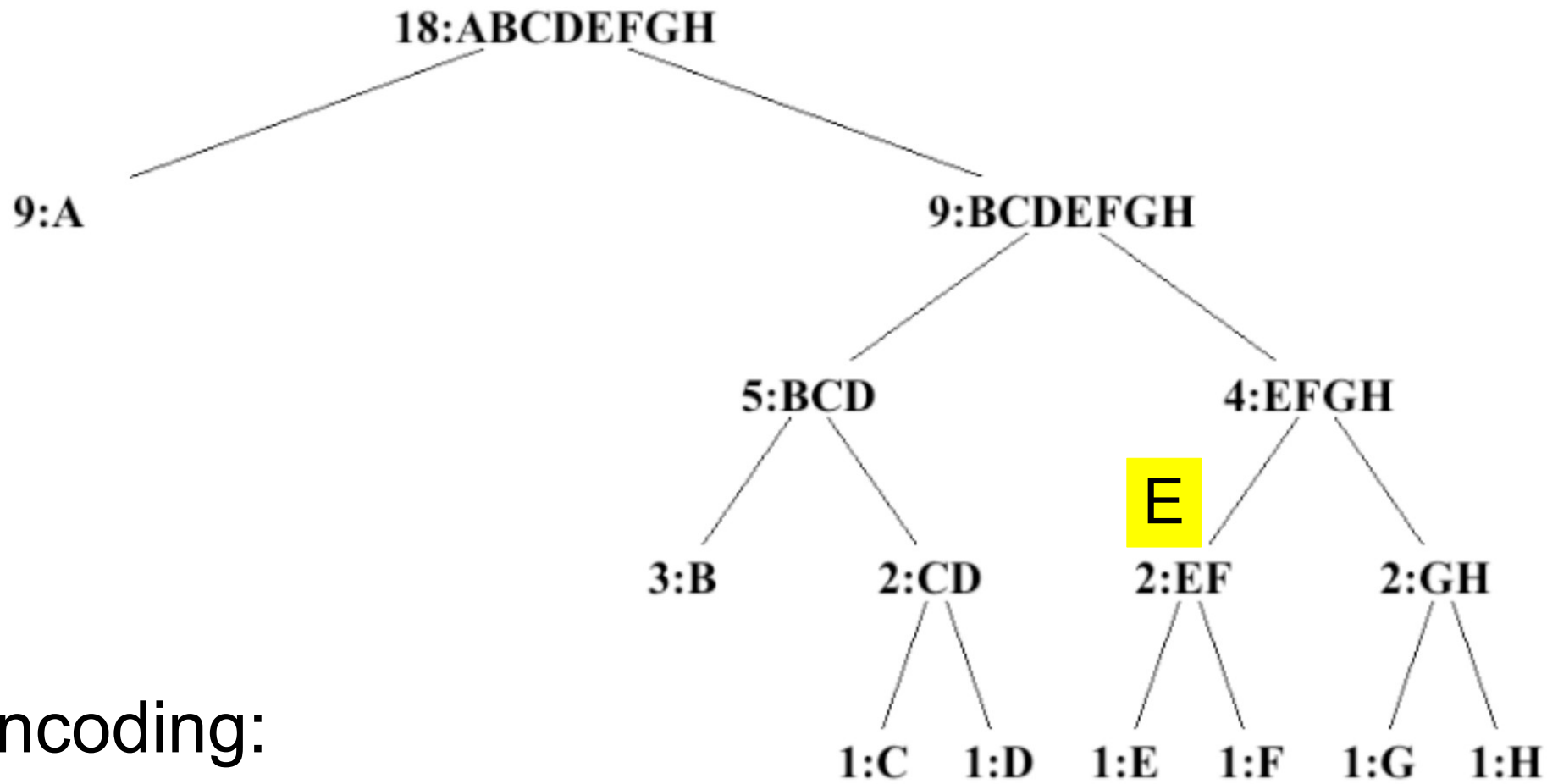

Encoding:

BACADA**E**AFABBAAGAH

100 0 1010 0 1011 0 110

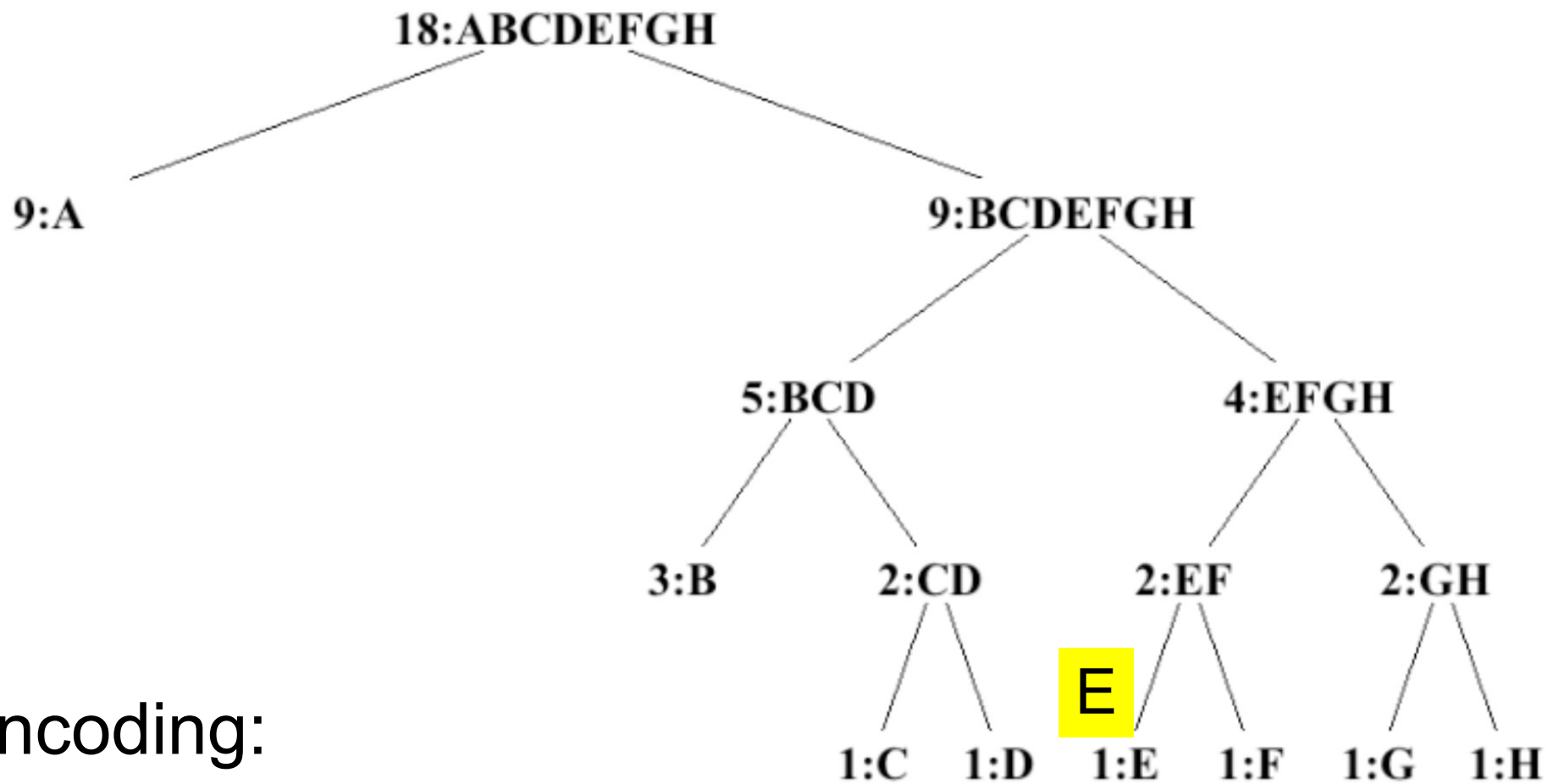

Encoding:

BACADA**E**AFABBAAGAH

100 0 1010 0 1011 0 1100

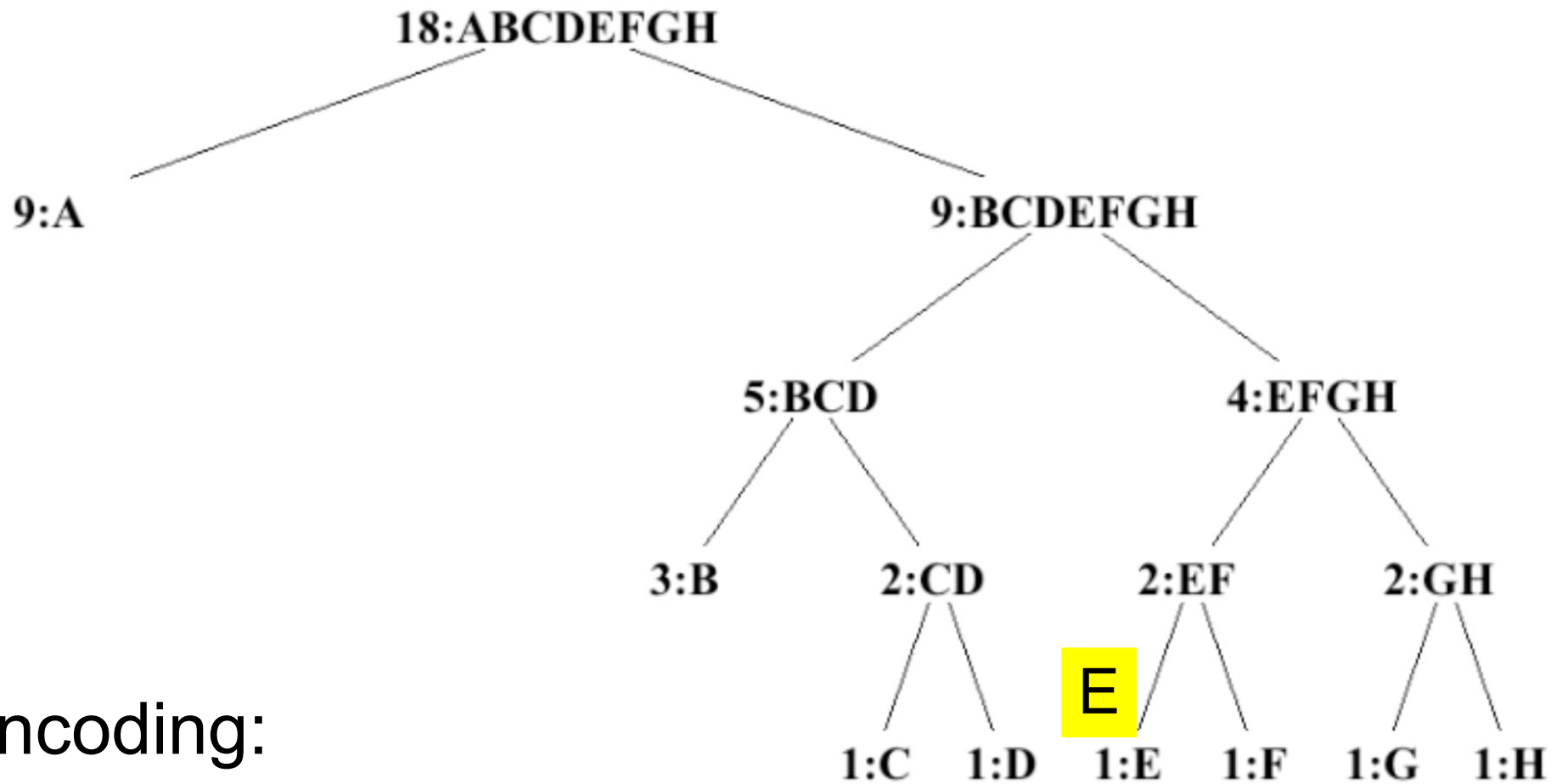

Encoding:

BACADA**E**AFABBAAGAH

100 0 1010 0 1011 0 1100 ... and so on

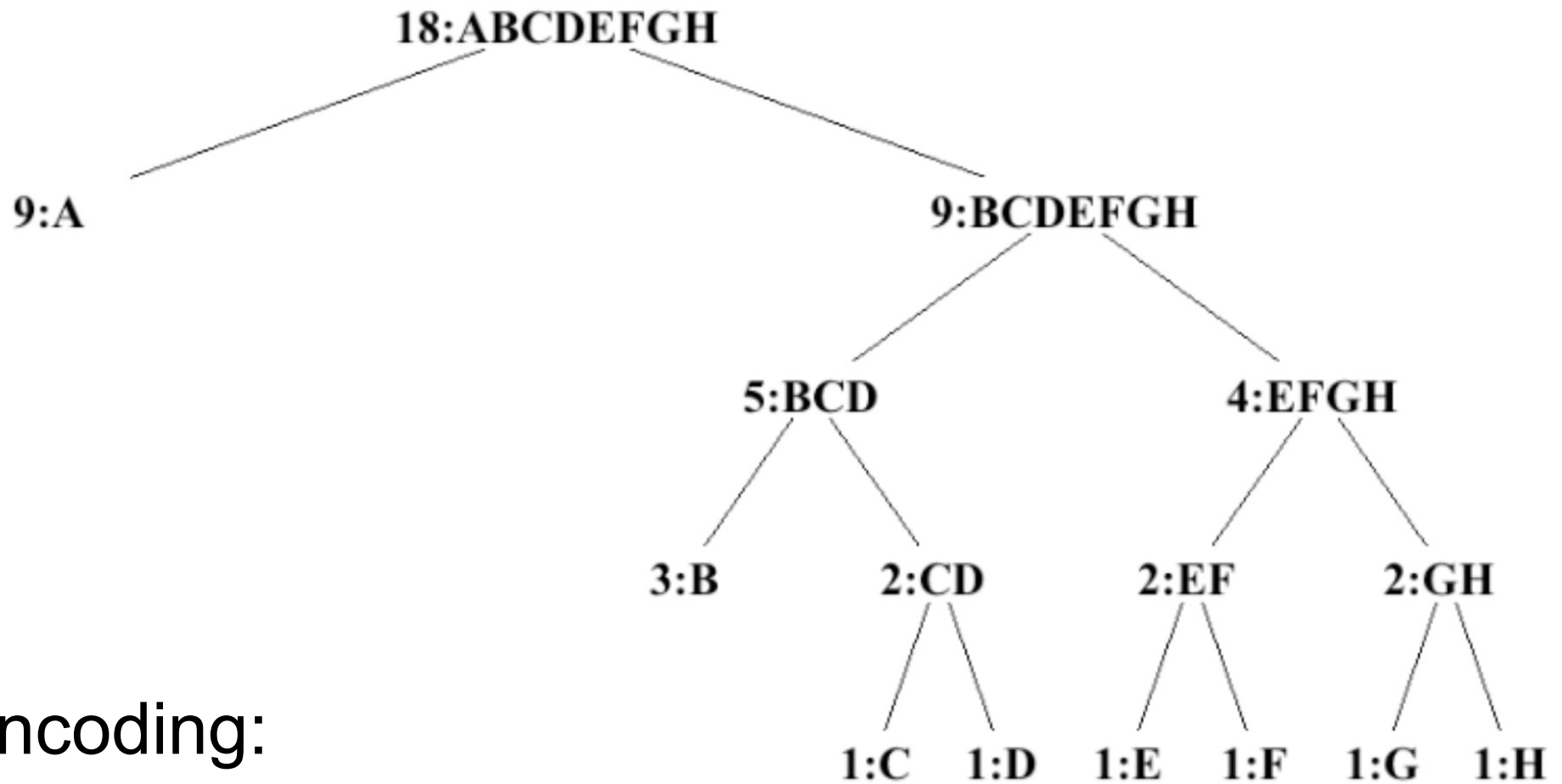

Encoding:

BACADAEAFABBAAGAH

100010100101101100011010100100000111001111

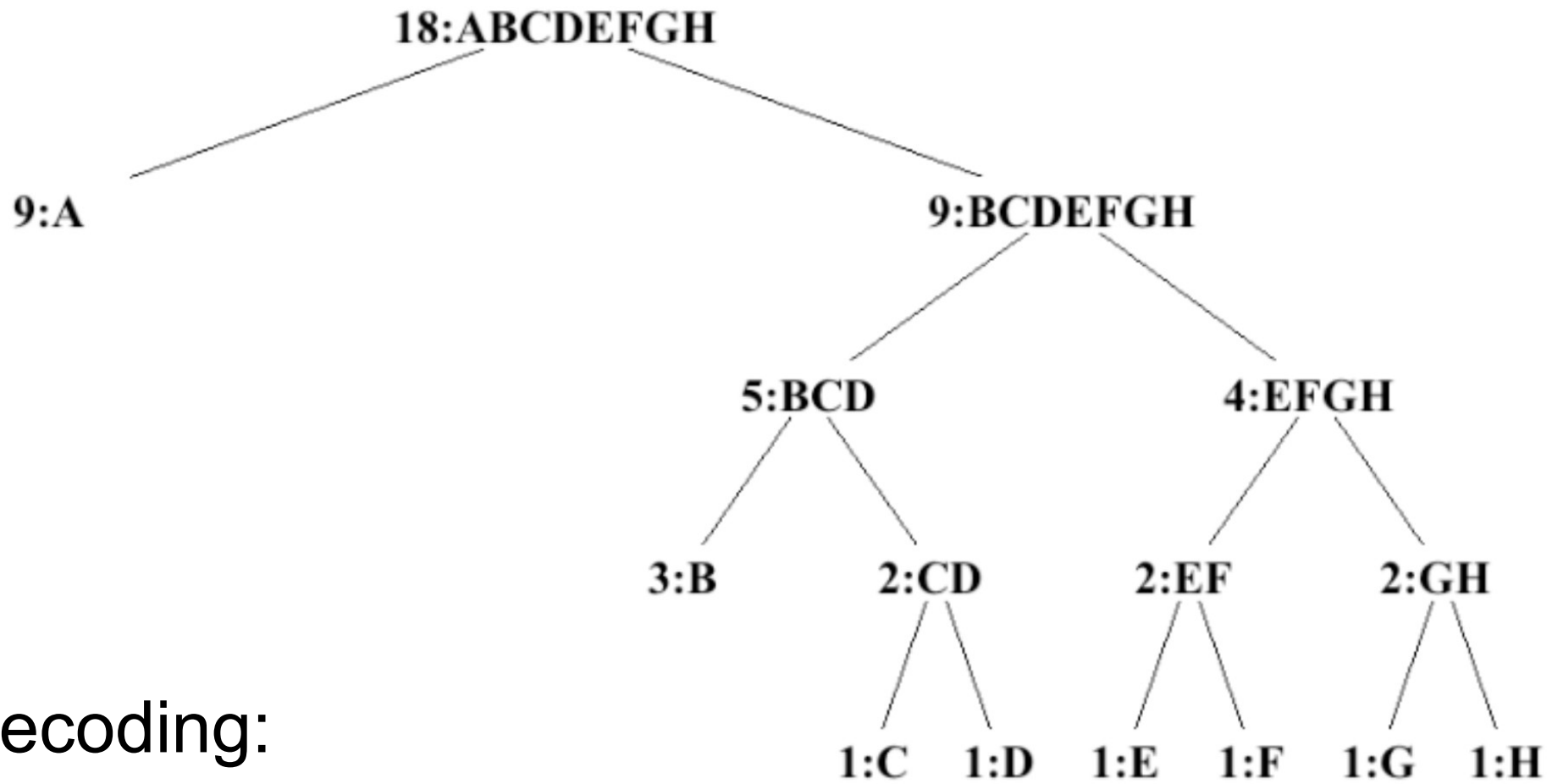

Decoding:

100010100101101100

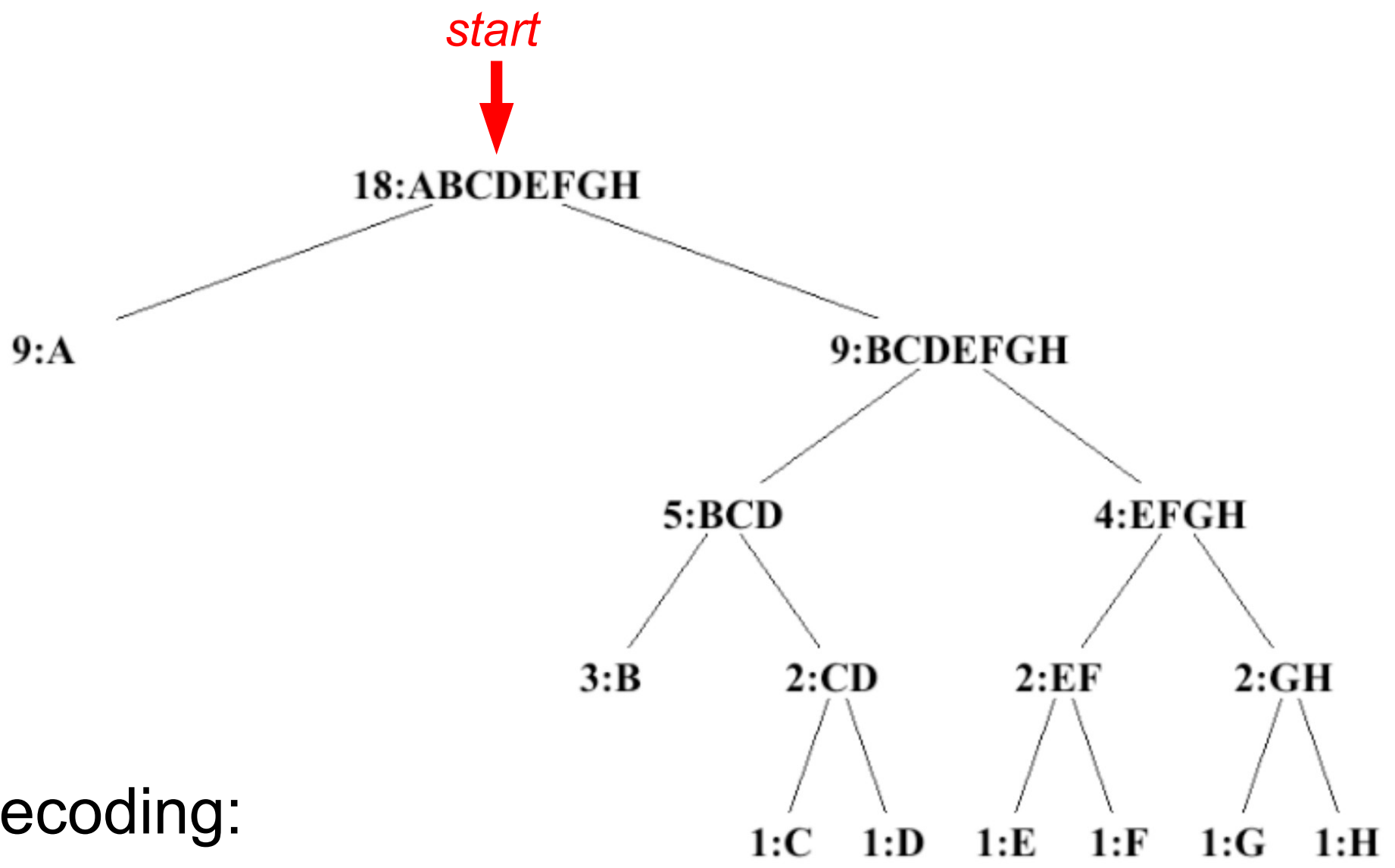

Decoding:

100010100101101100

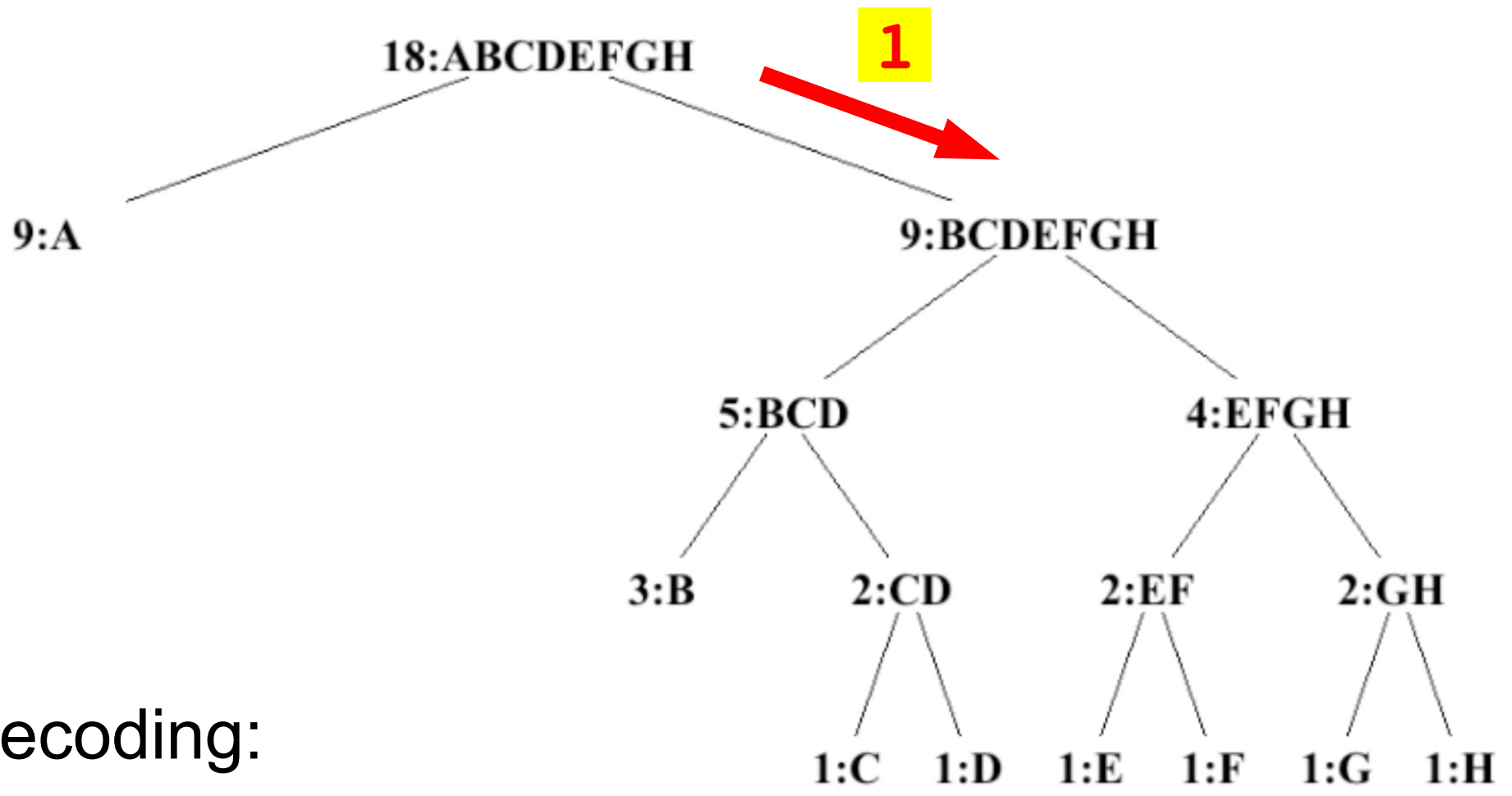

Decoding:

100010100101101100

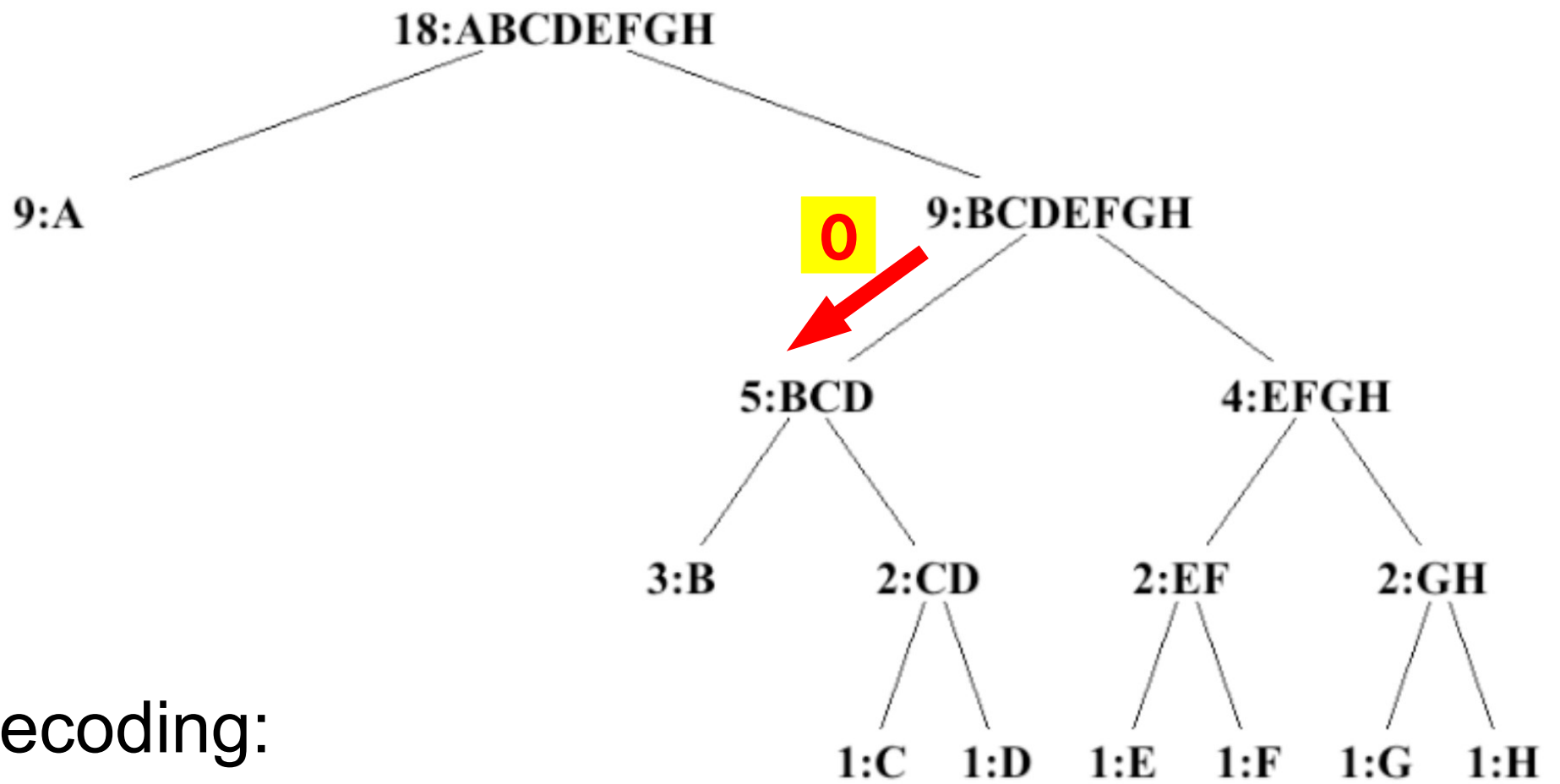

Decoding:

100010100101101100

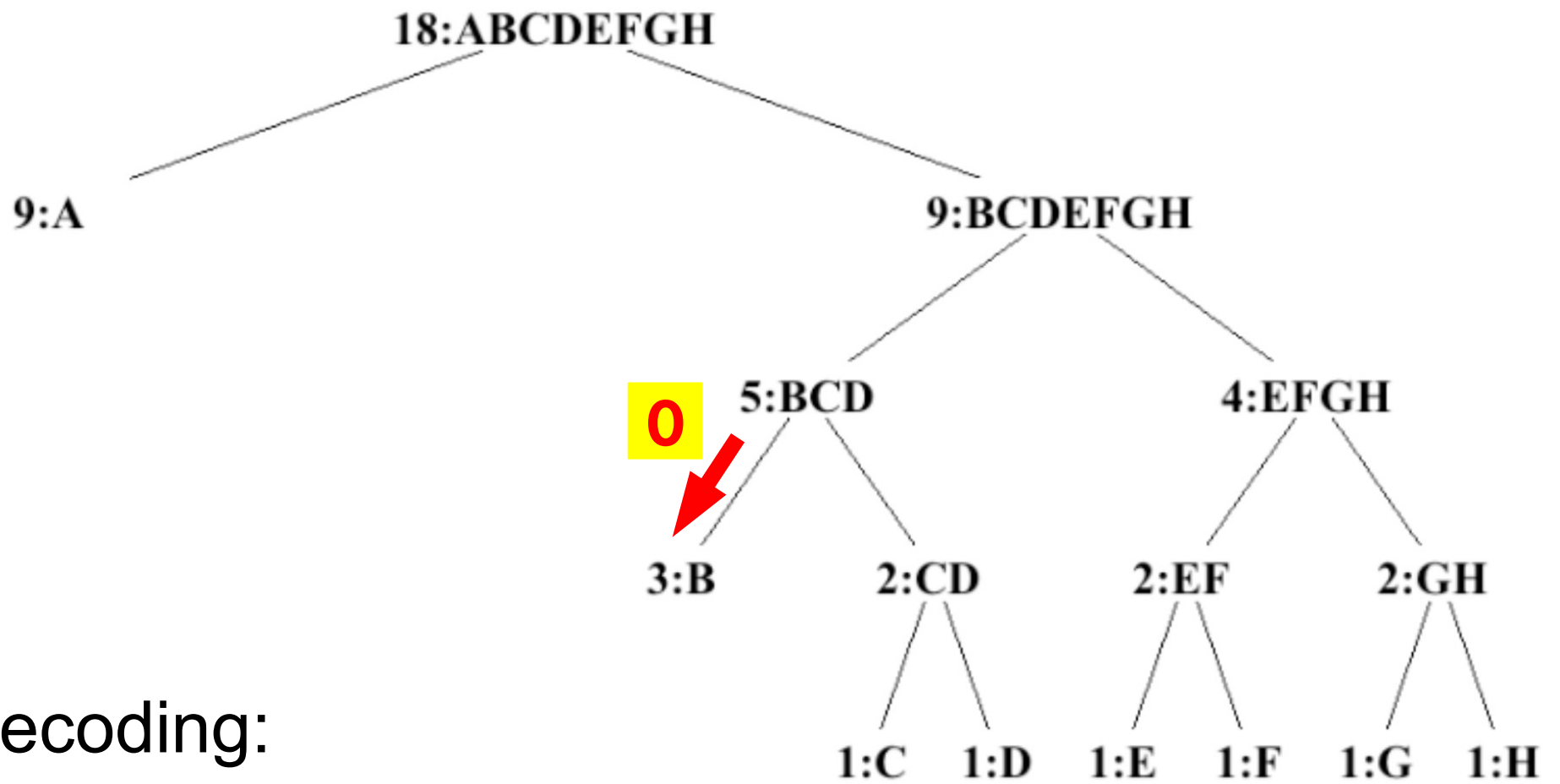

Decoding:

100010100101101100

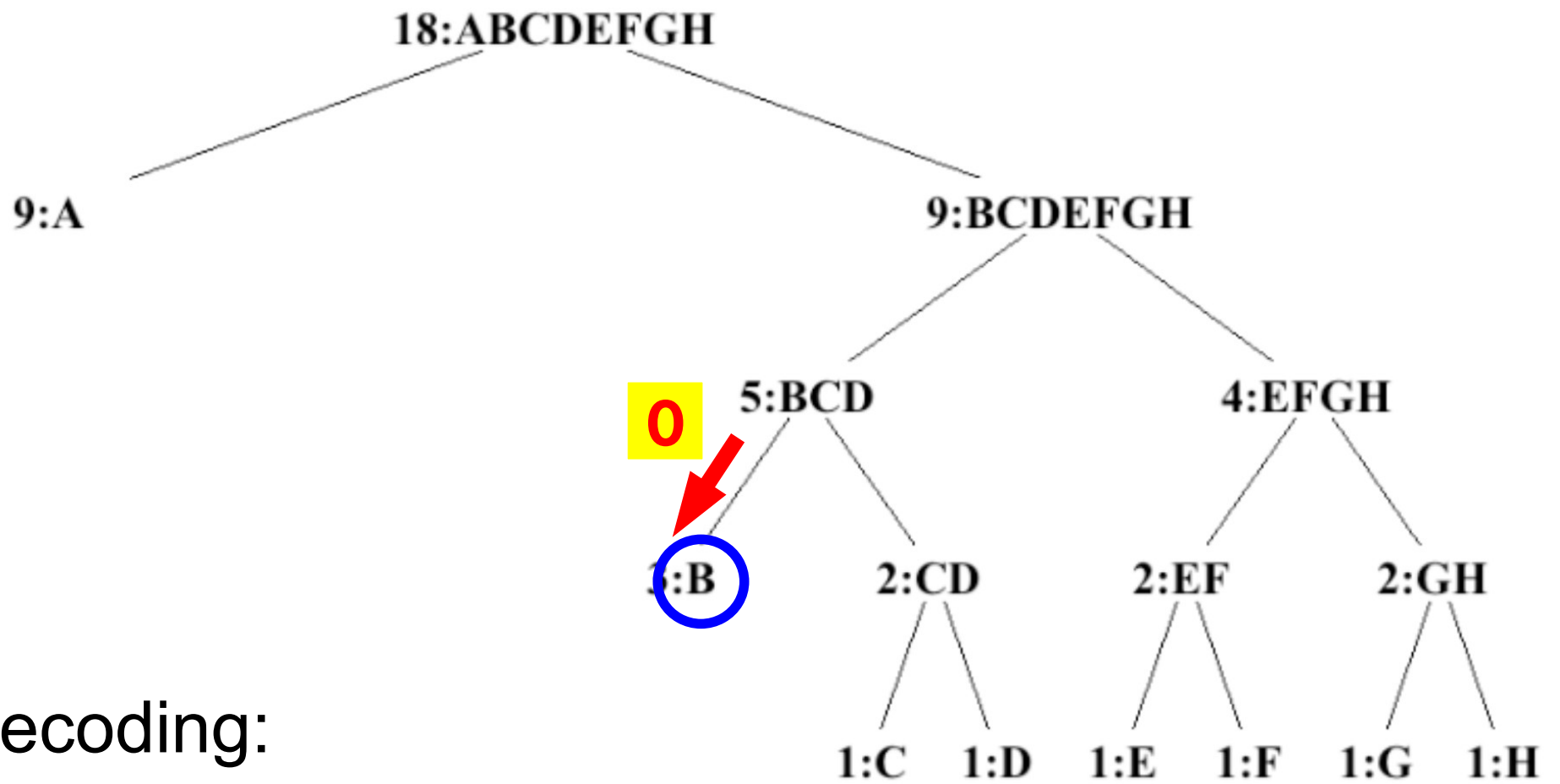

Decoding:

100010100101101100

B

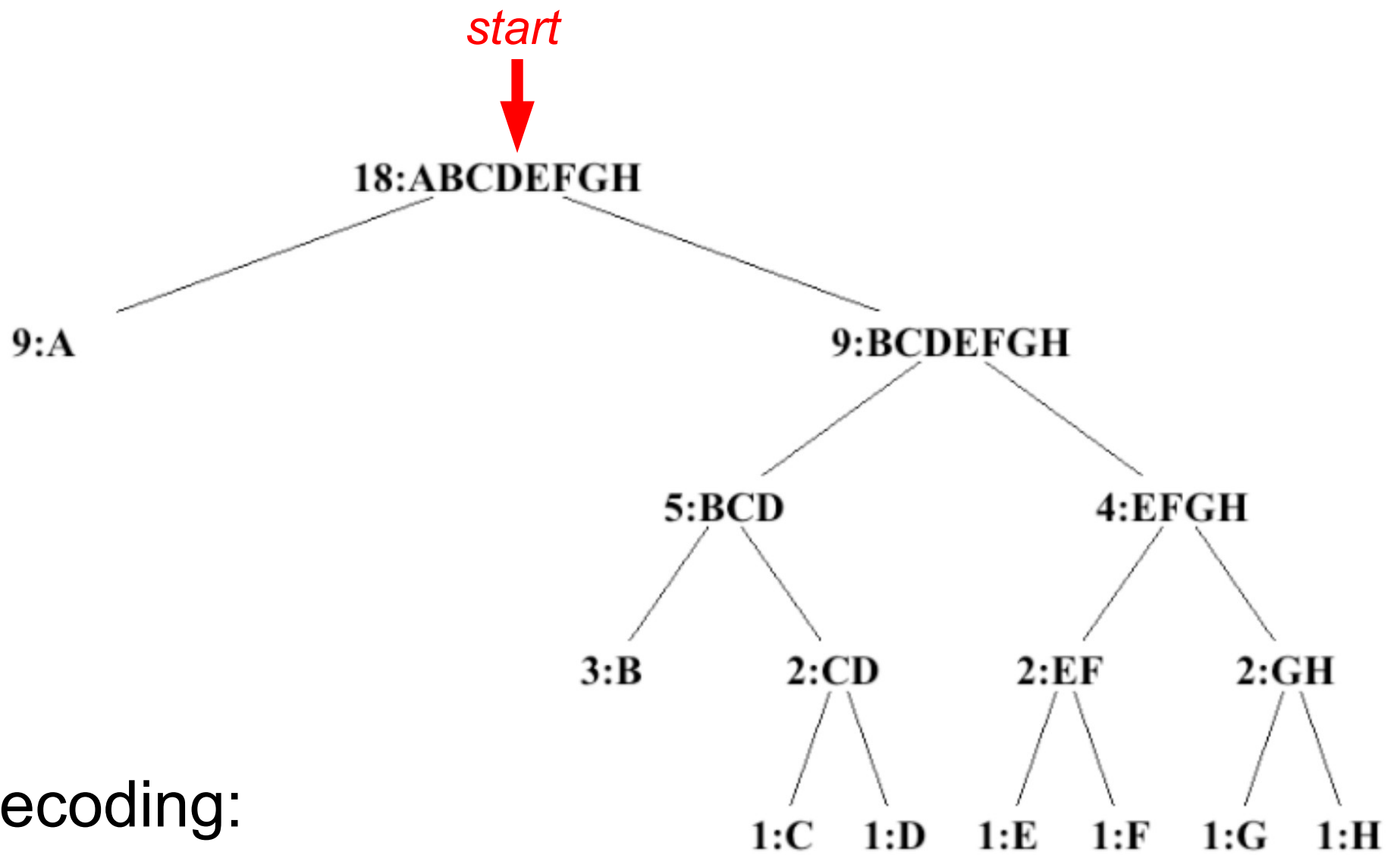

Decoding:

100010100101101100

B

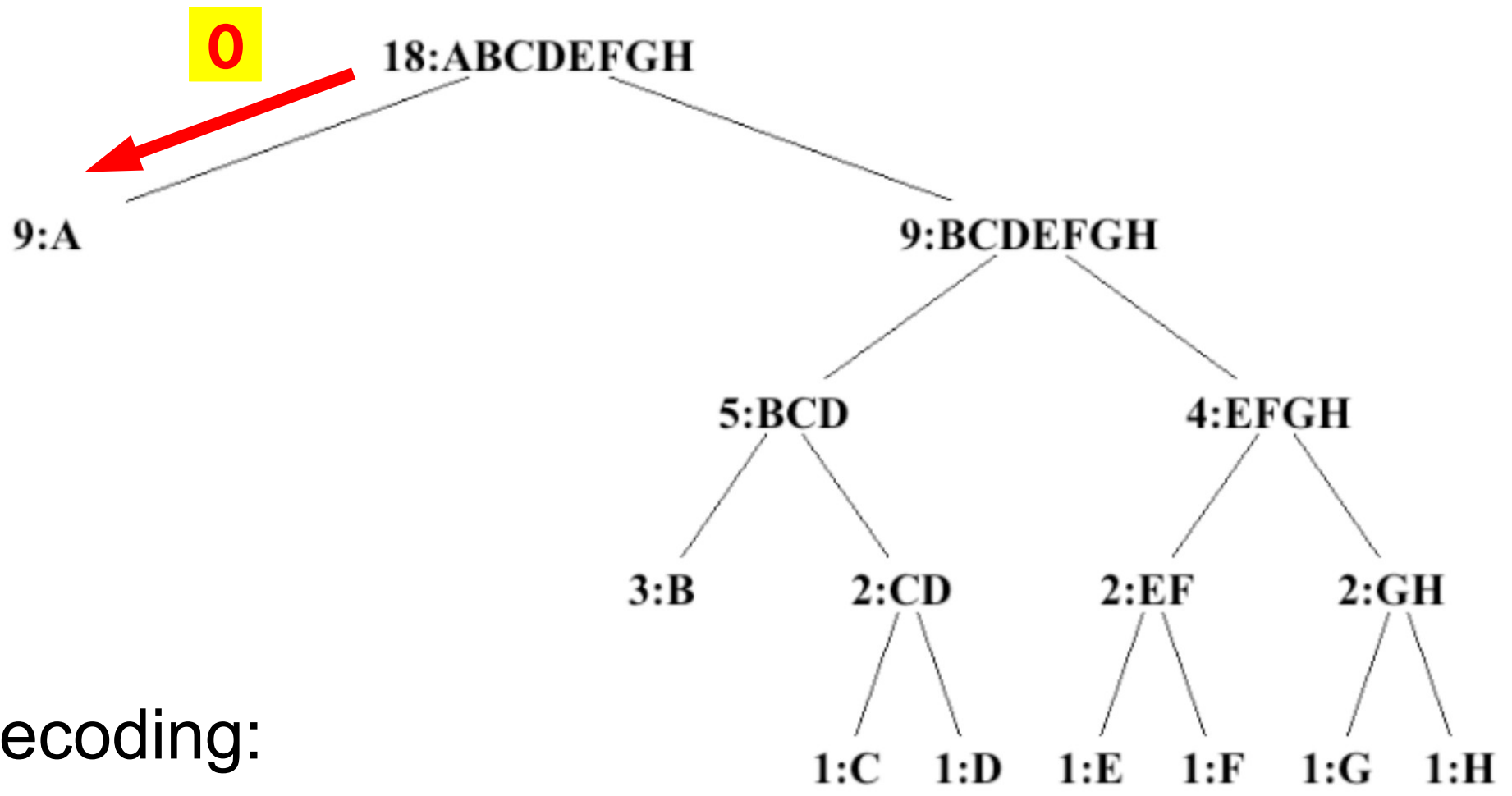

Decoding:

100010100101101100

B

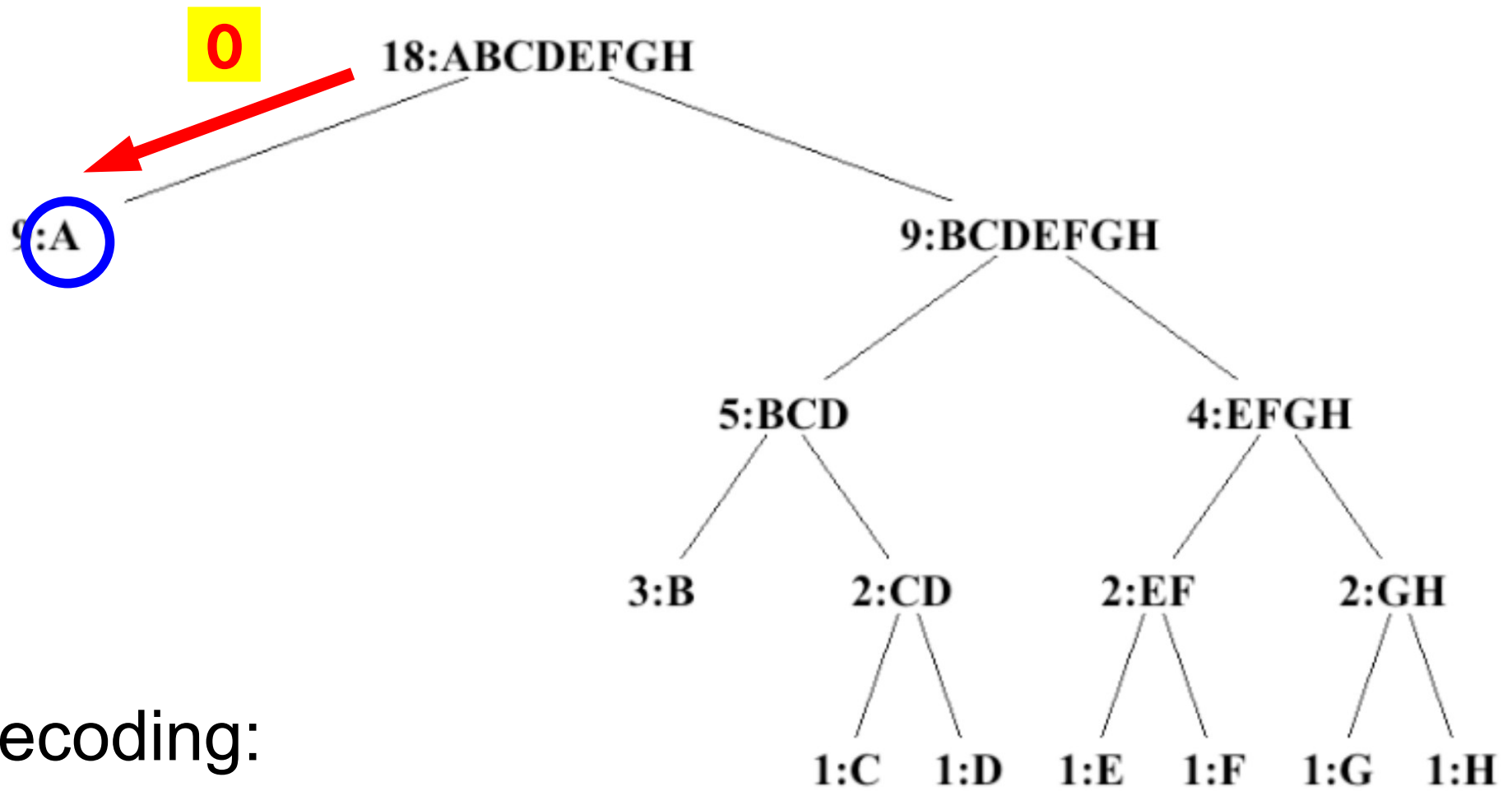

Decoding:

100010100101101100

BA

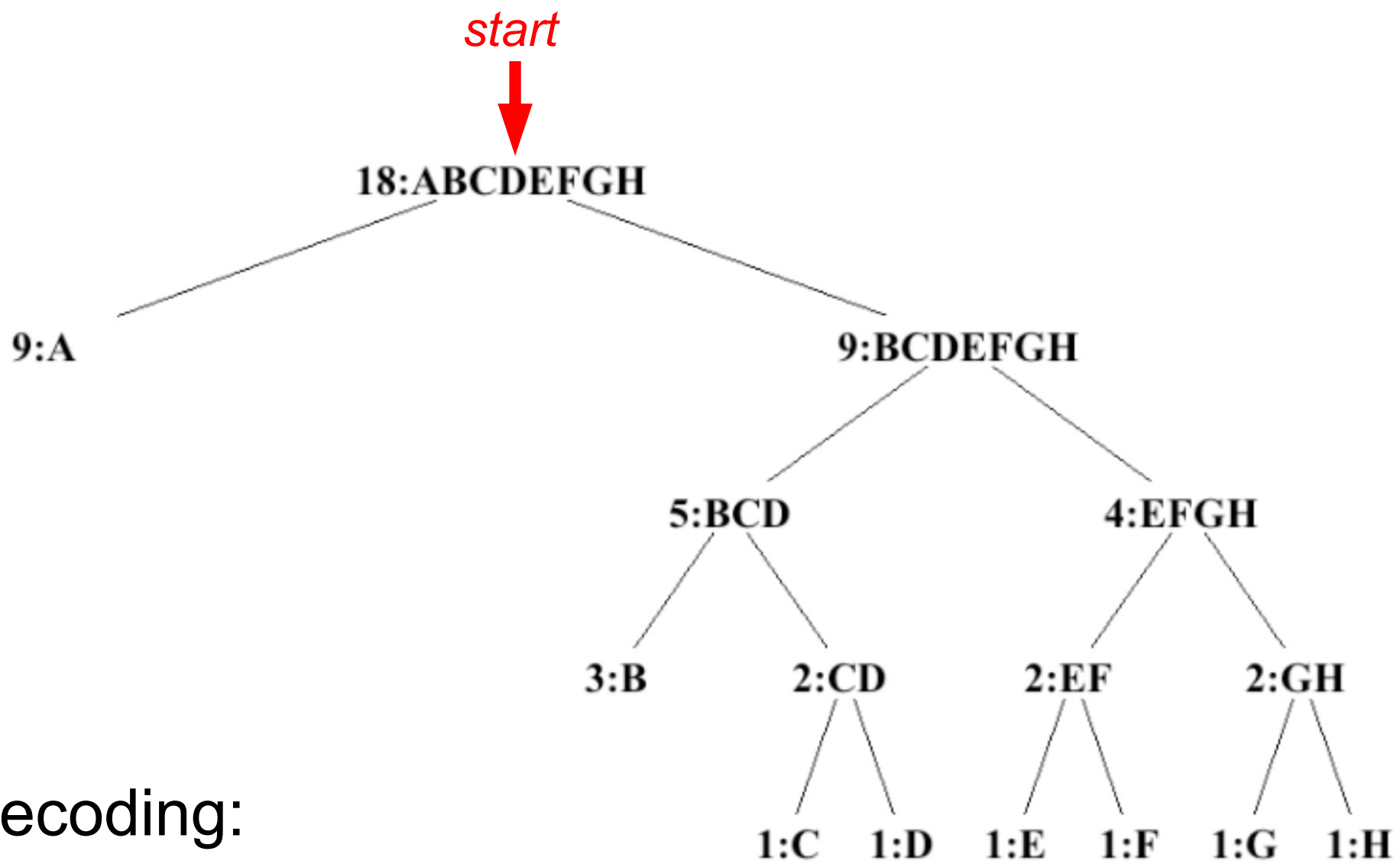

Decoding:

100010100101101100

BA

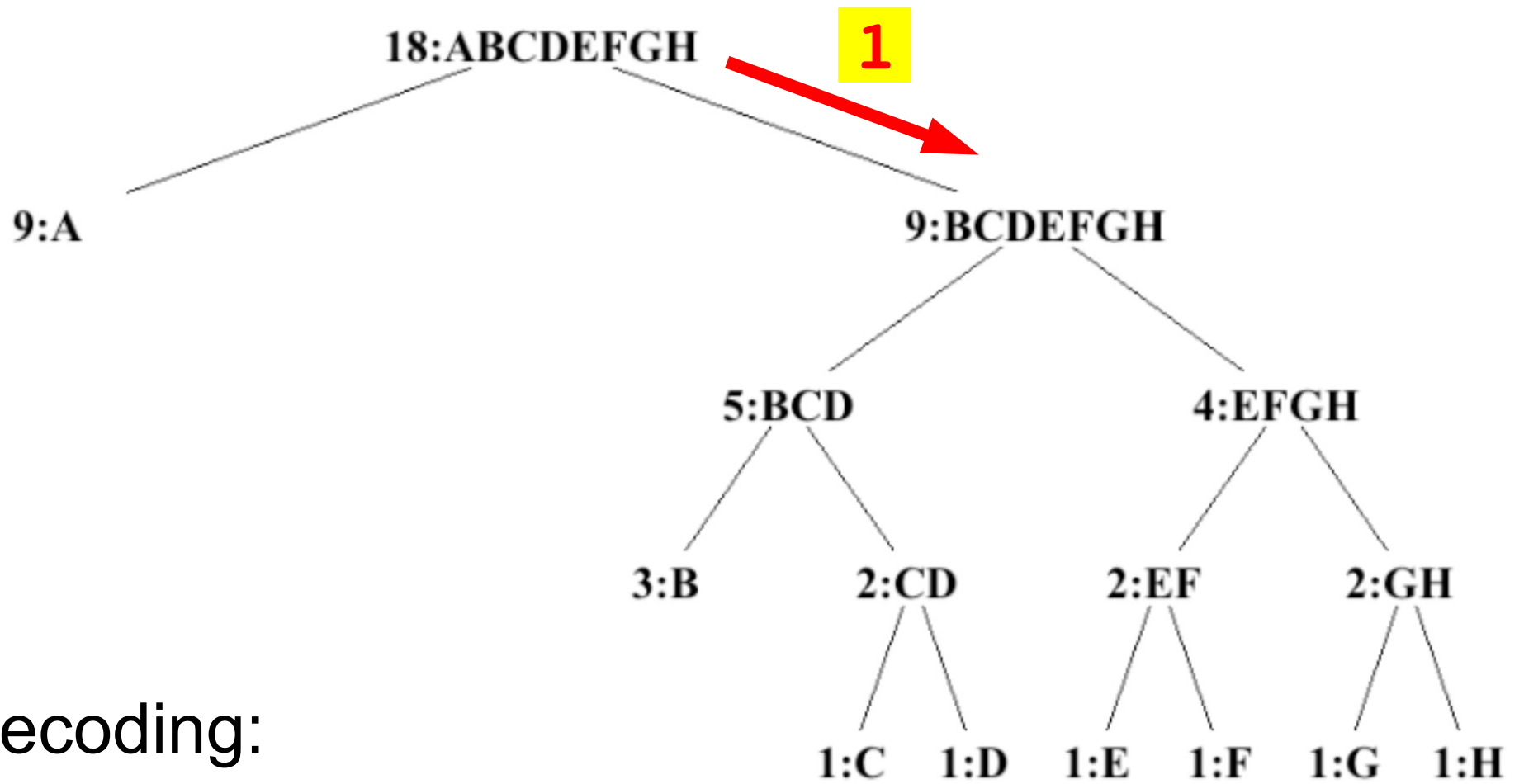

Decoding:

100010100101101100

BA

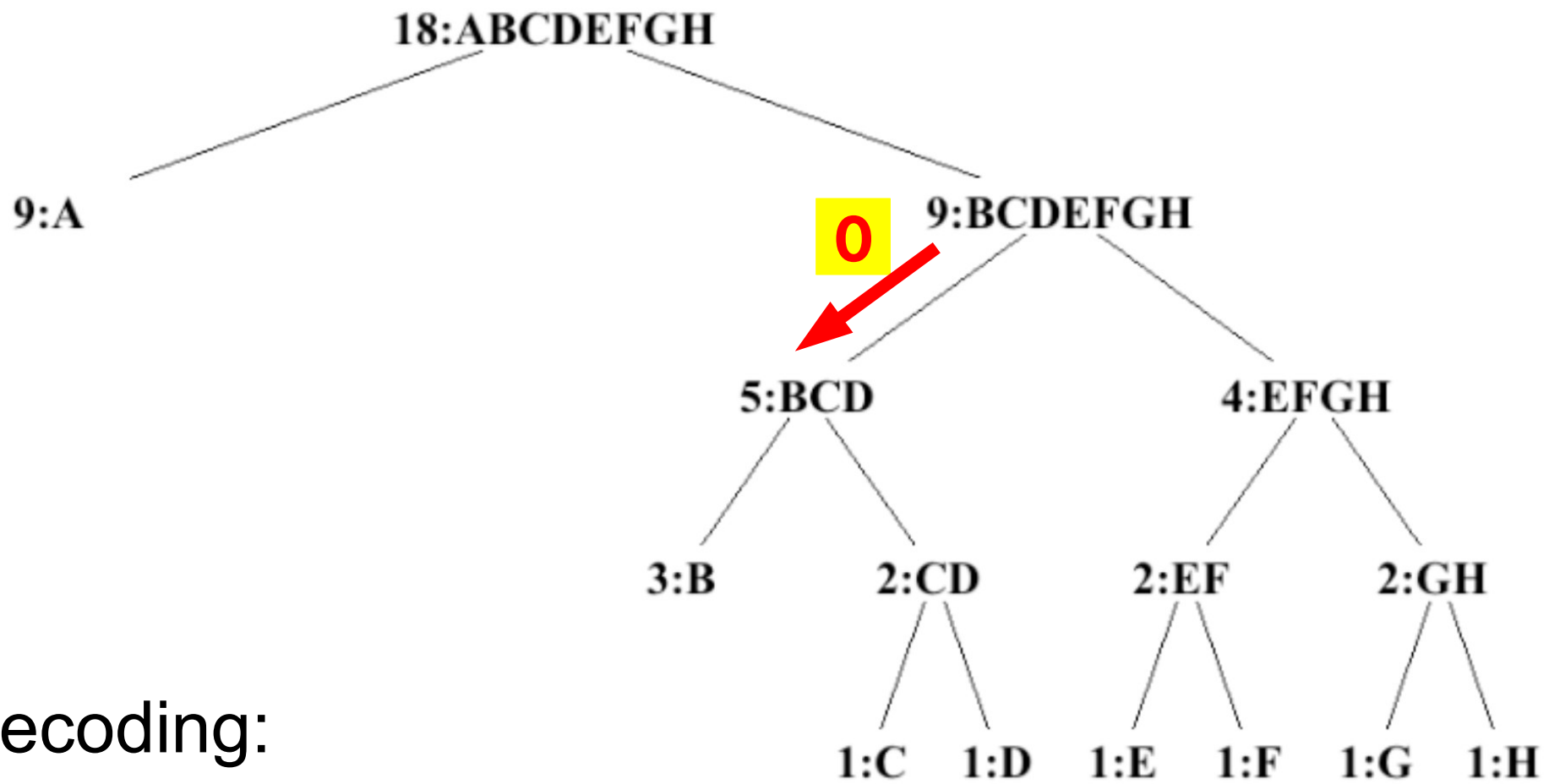

Decoding:

100010100101101100

BA

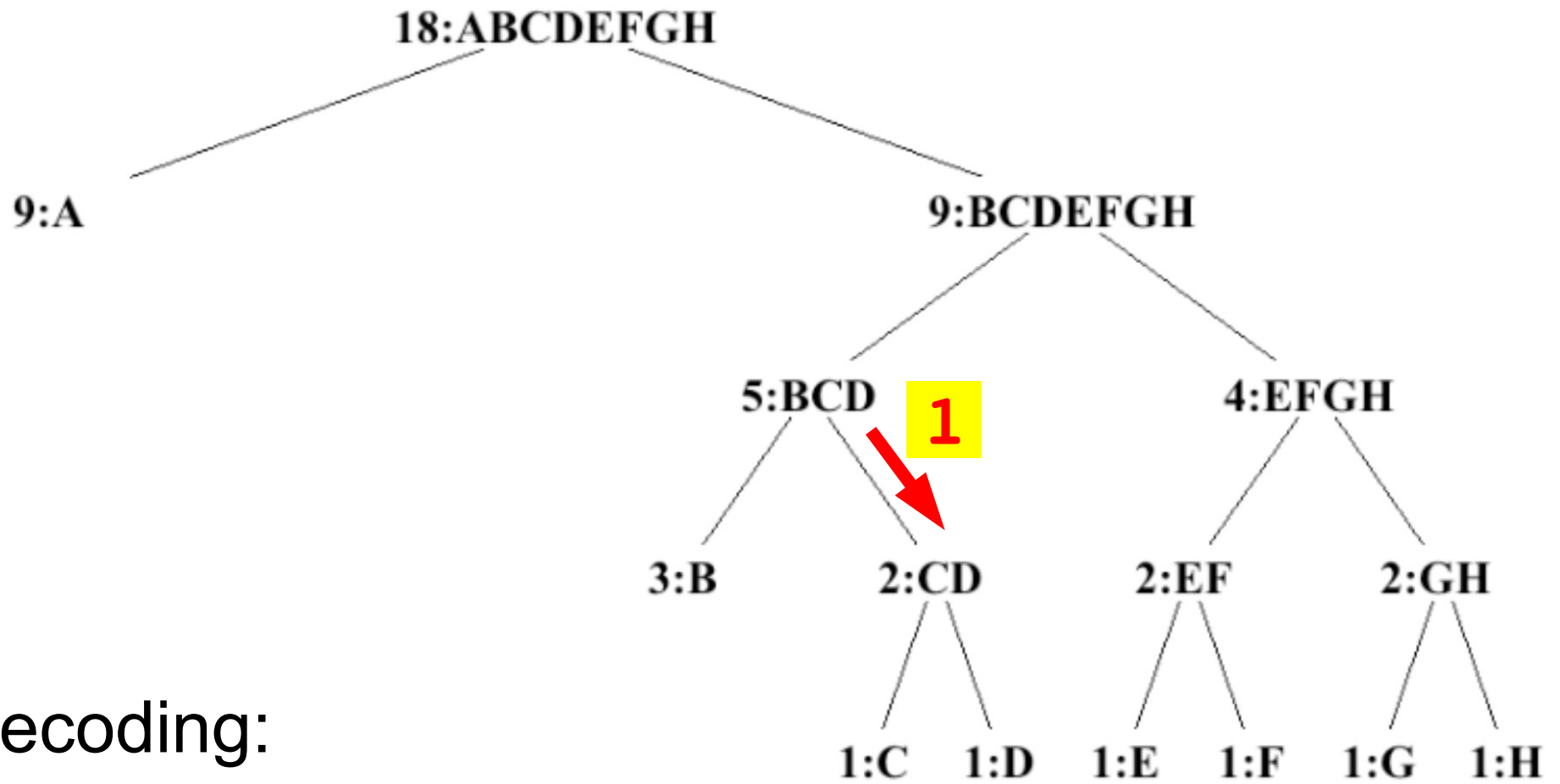

Decoding:

100010100101101100

BA

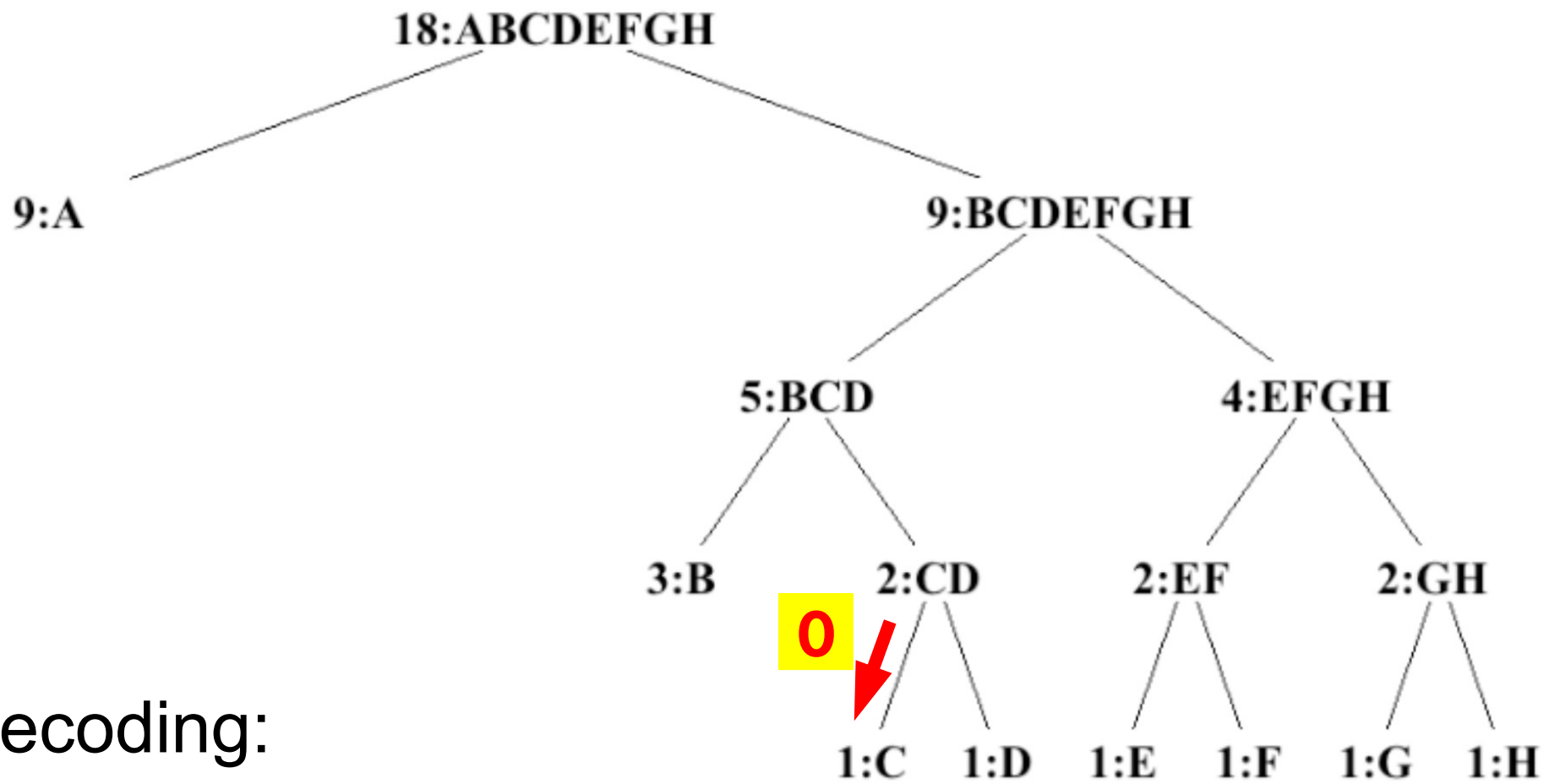

Decoding:

100010100101101100

BA

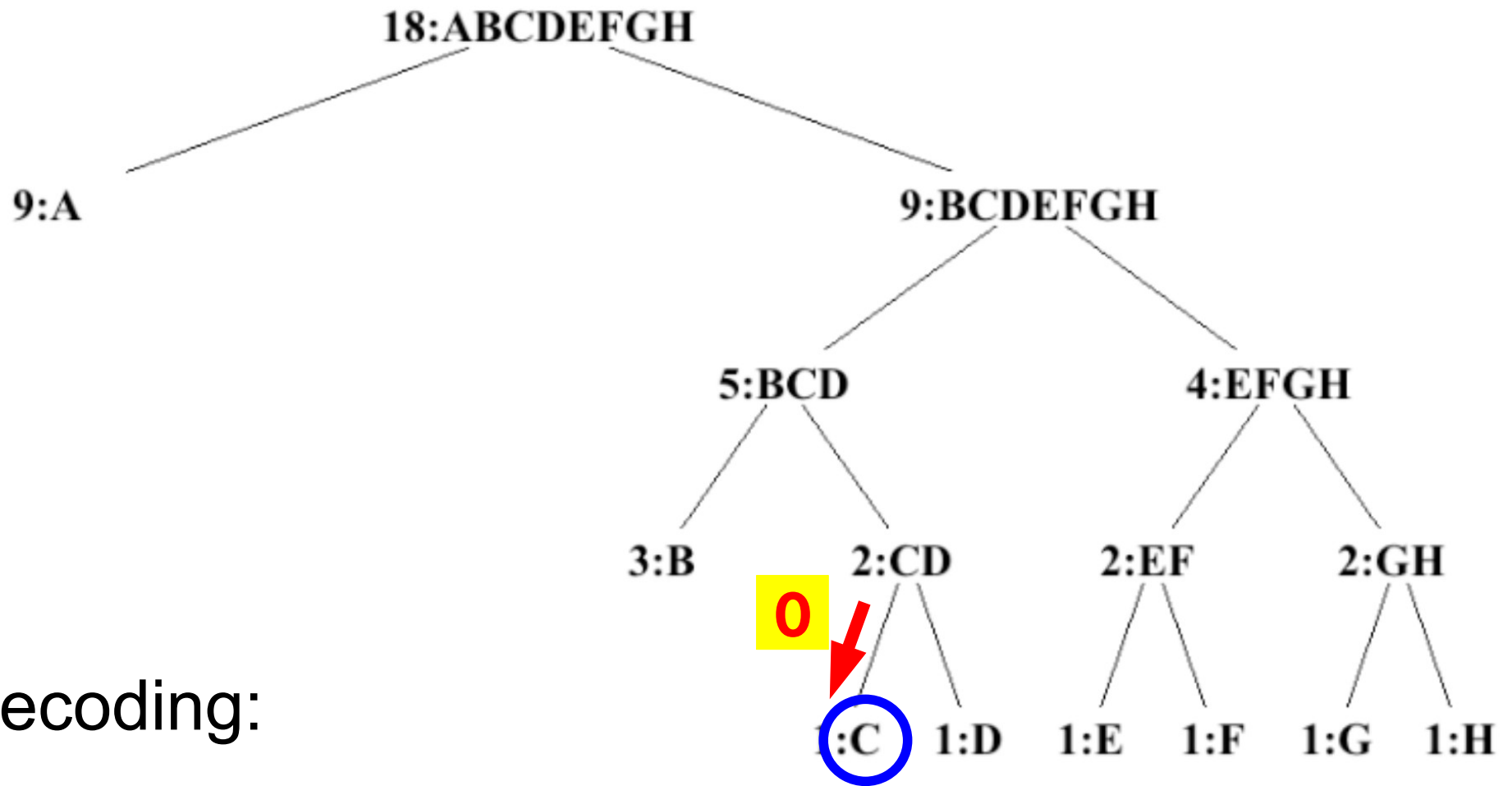

Decoding:

100010100101101100

BAC

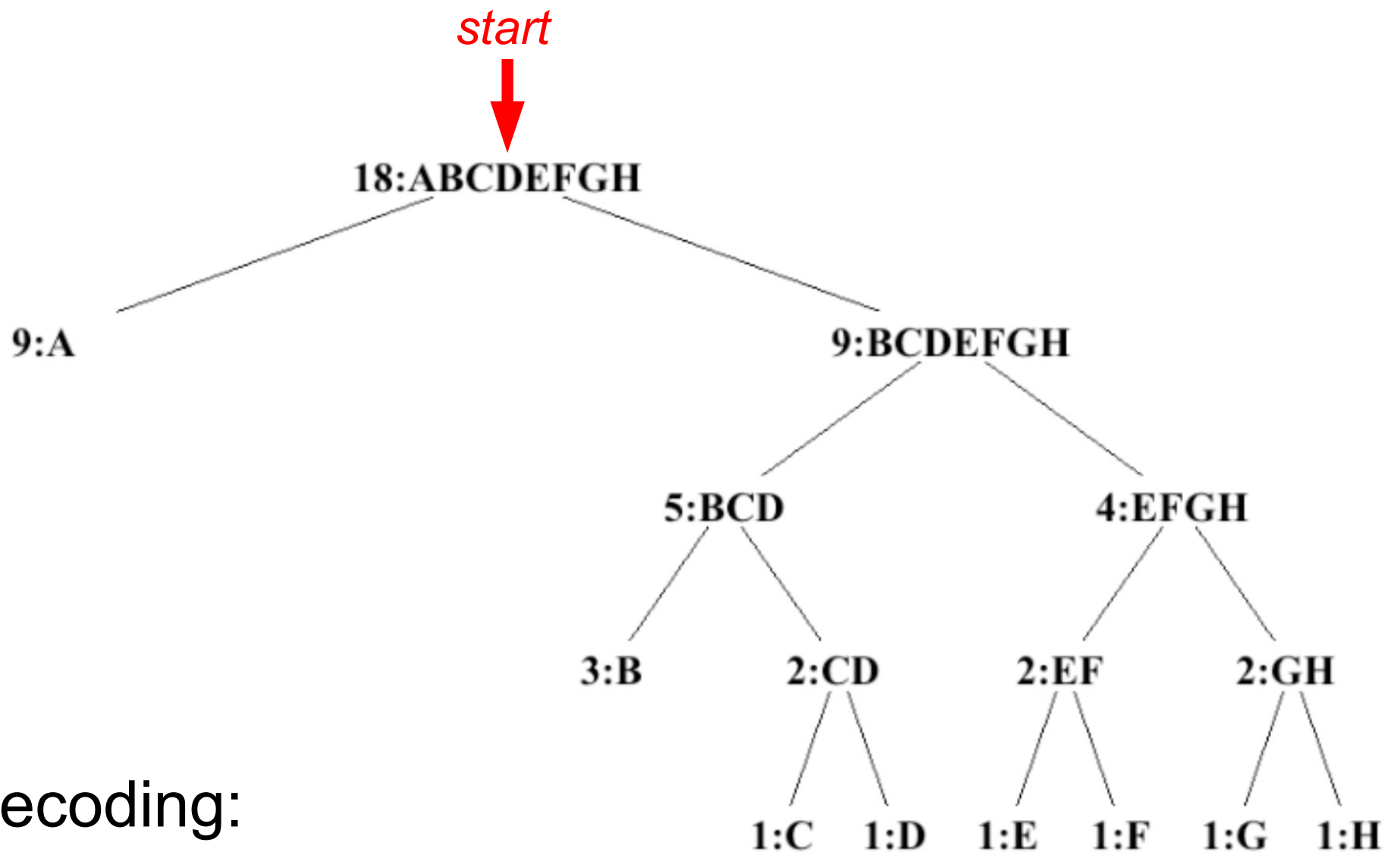

Decoding:

100010100101101100

BAC

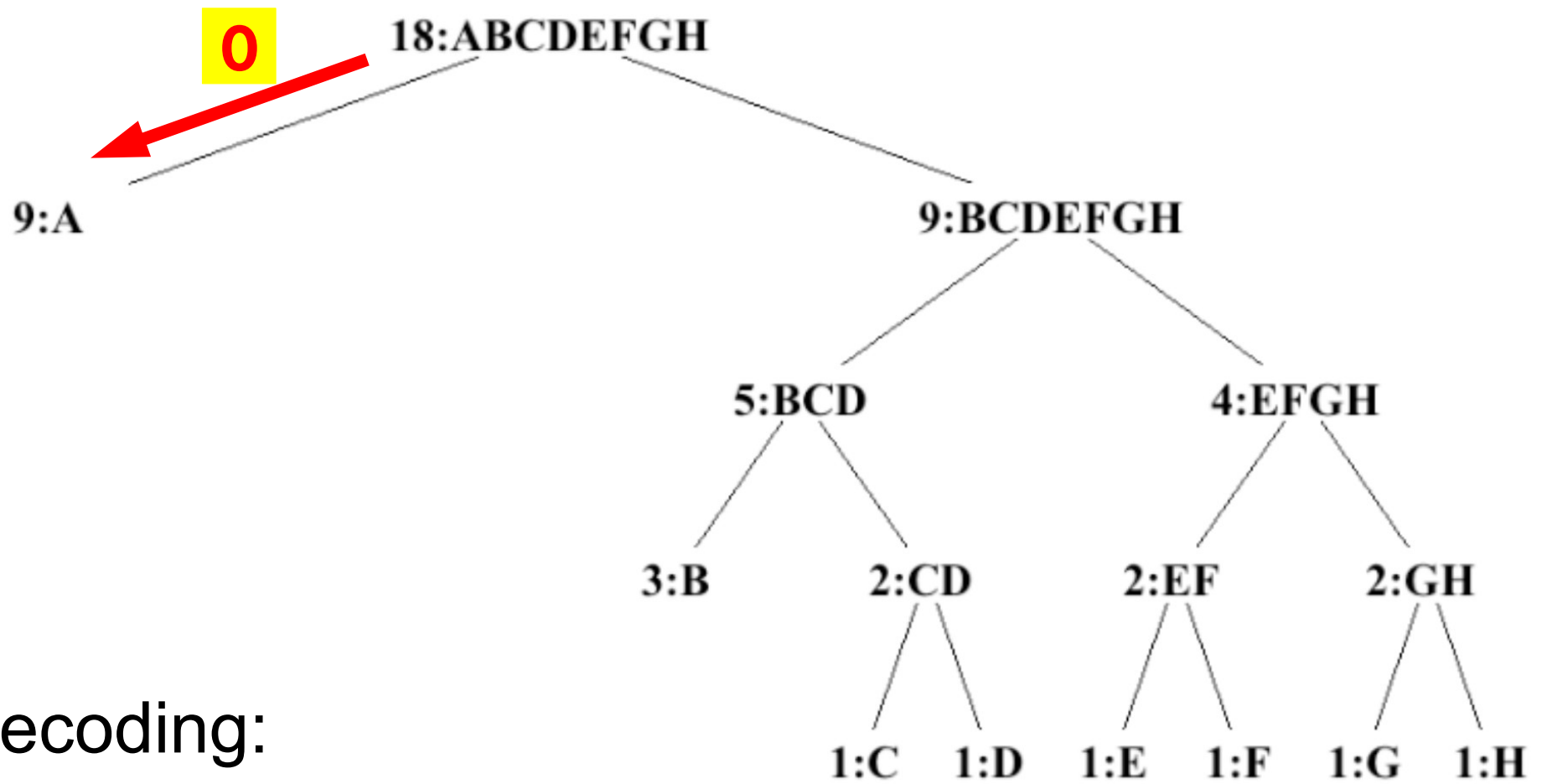

Decoding:

100010100101101100

BAC

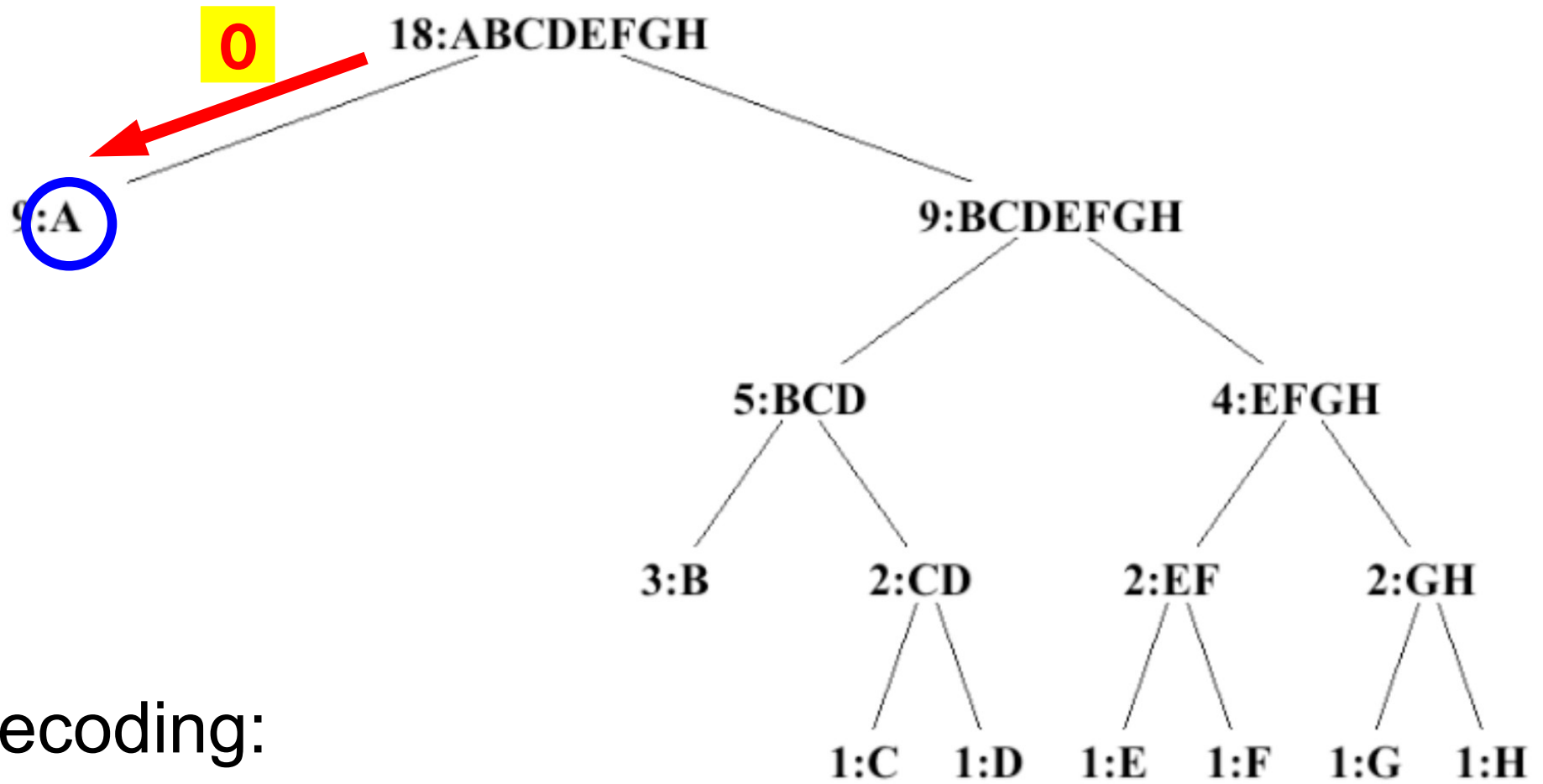

Decoding:

100010100101101100

BACA

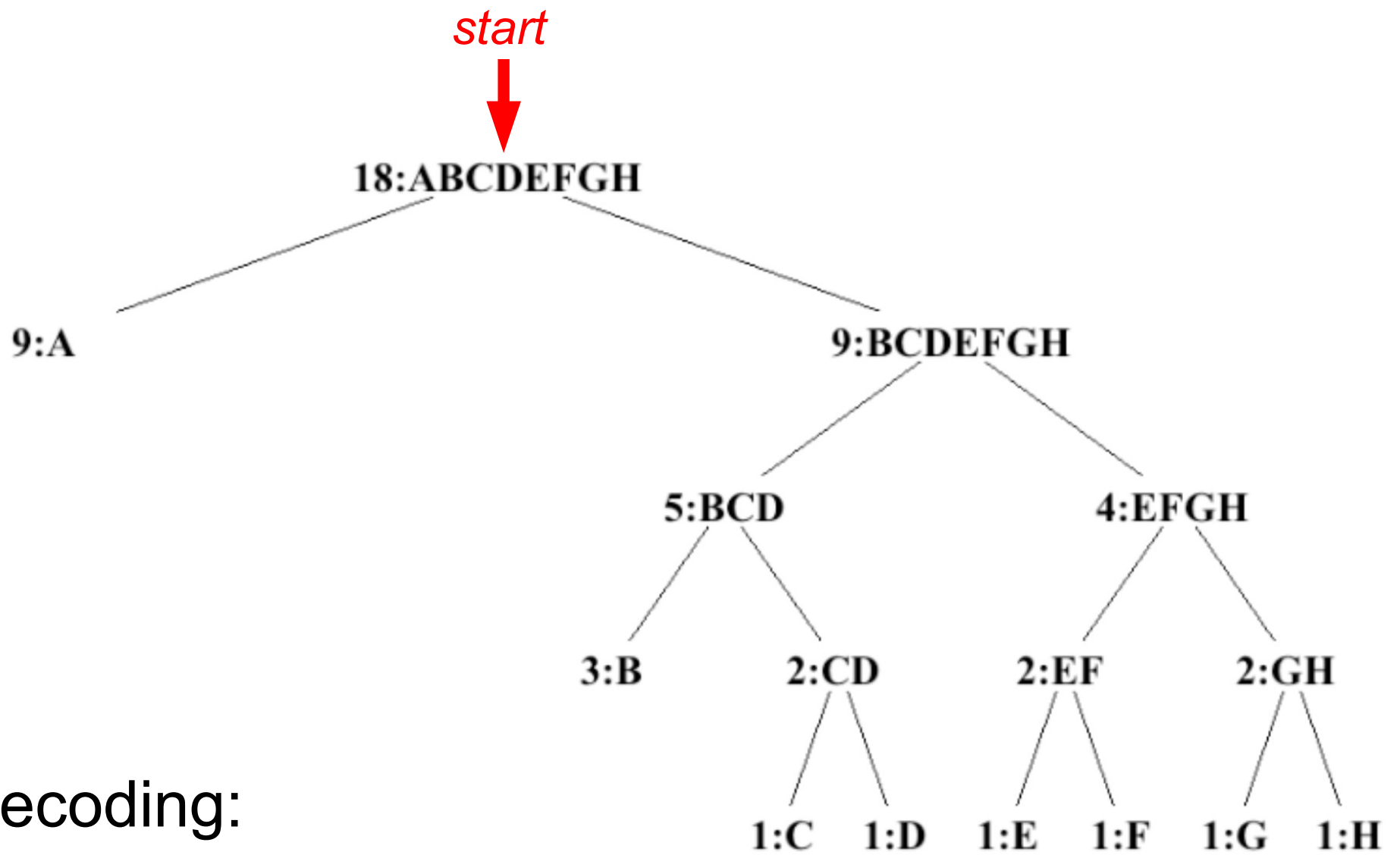

Decoding:

100010100101101100

BACA

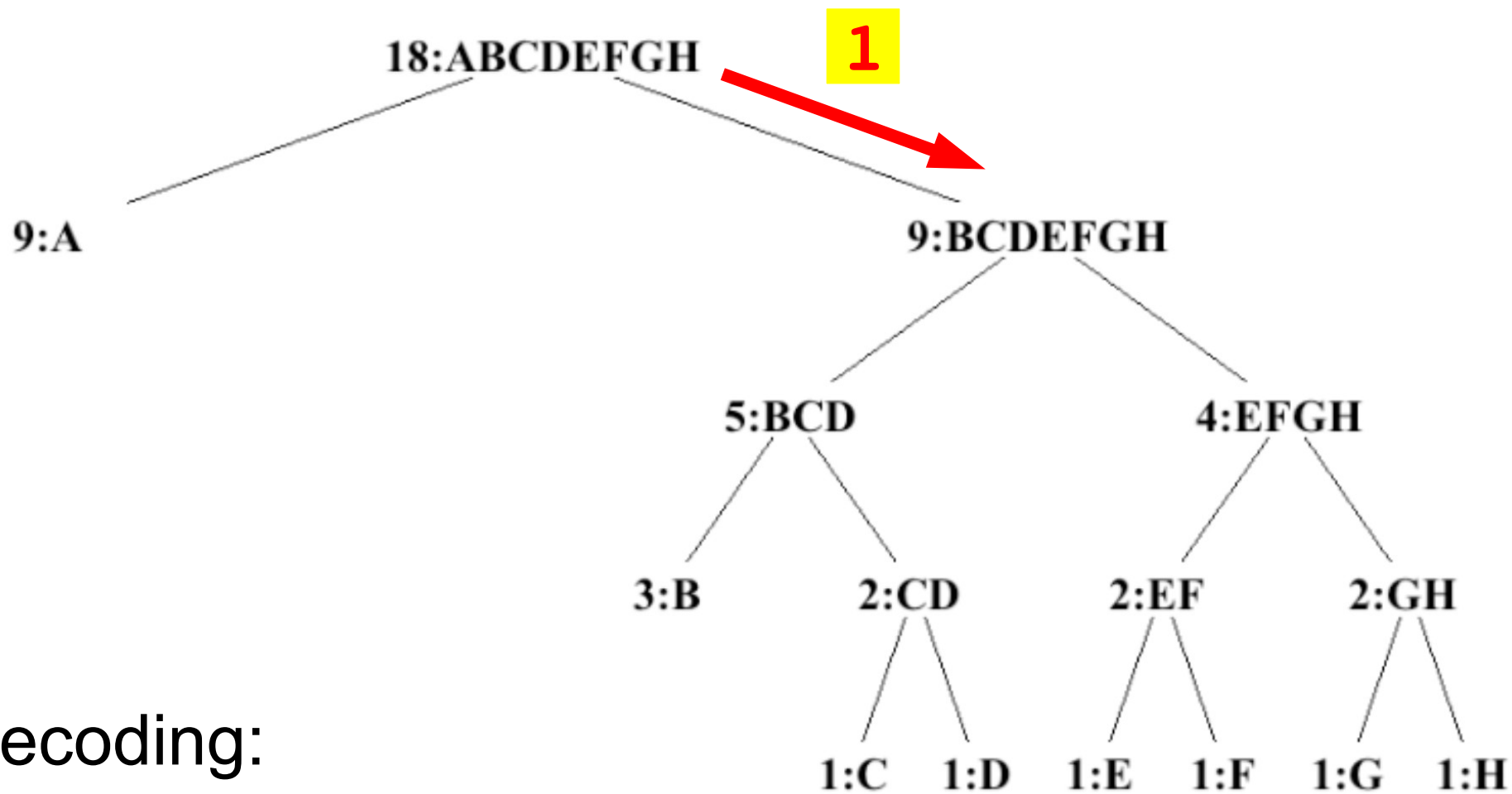

Decoding:

100010100101101100

BACA

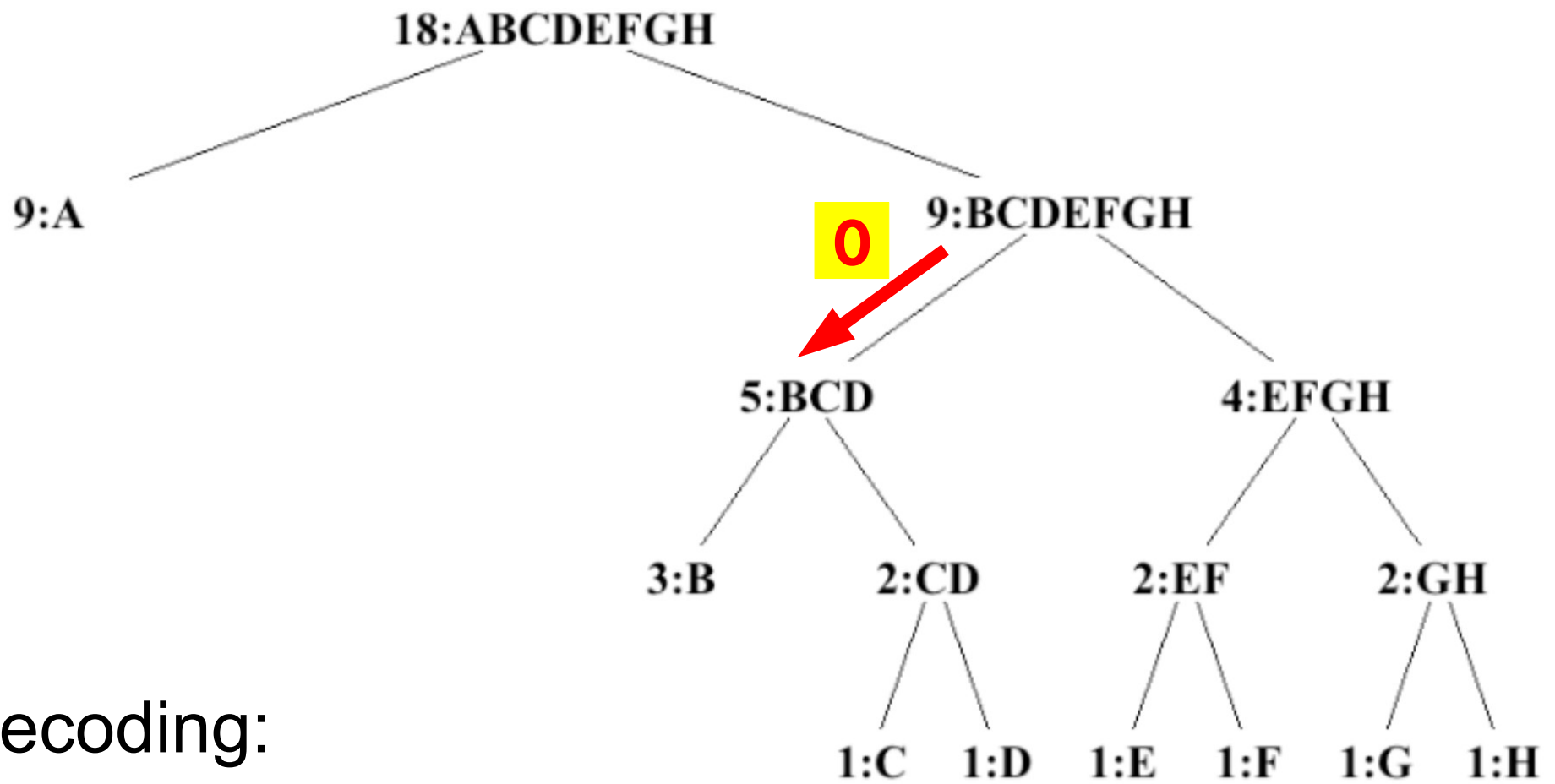

Decoding:

100010100101101100

BACA

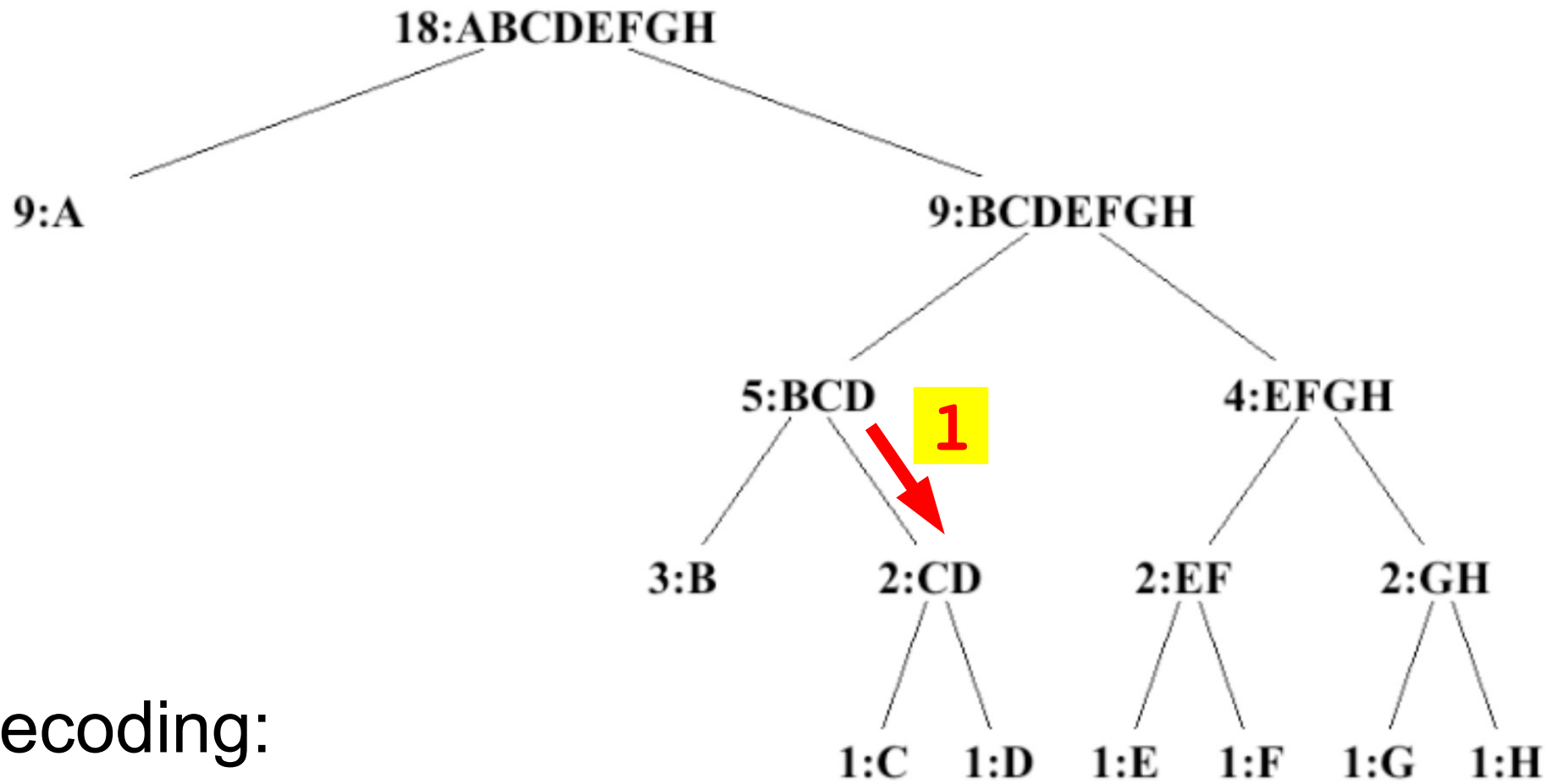

Decoding:

100010100101101100

BACA

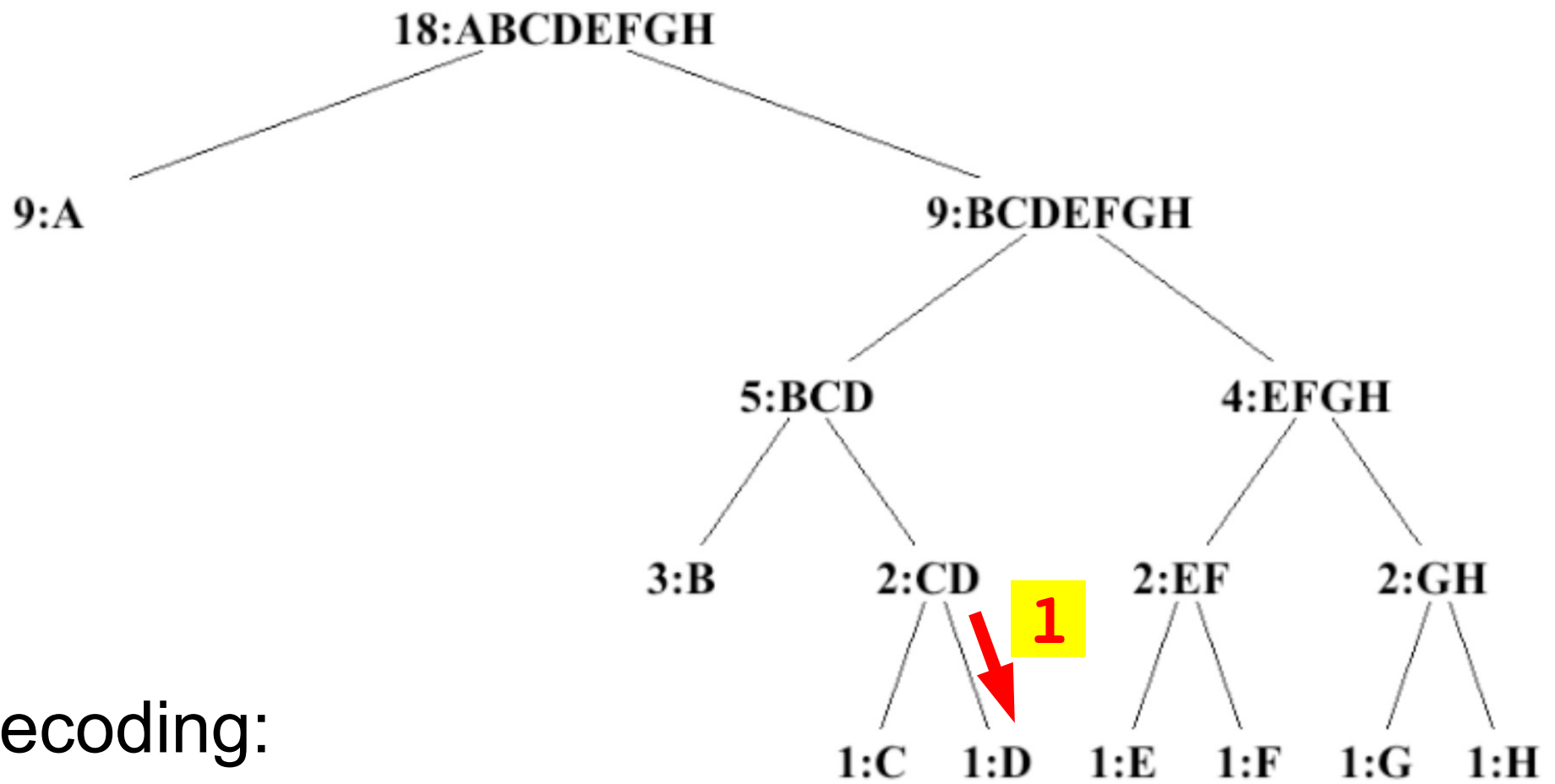

Decoding:

100010100101101100

BACA

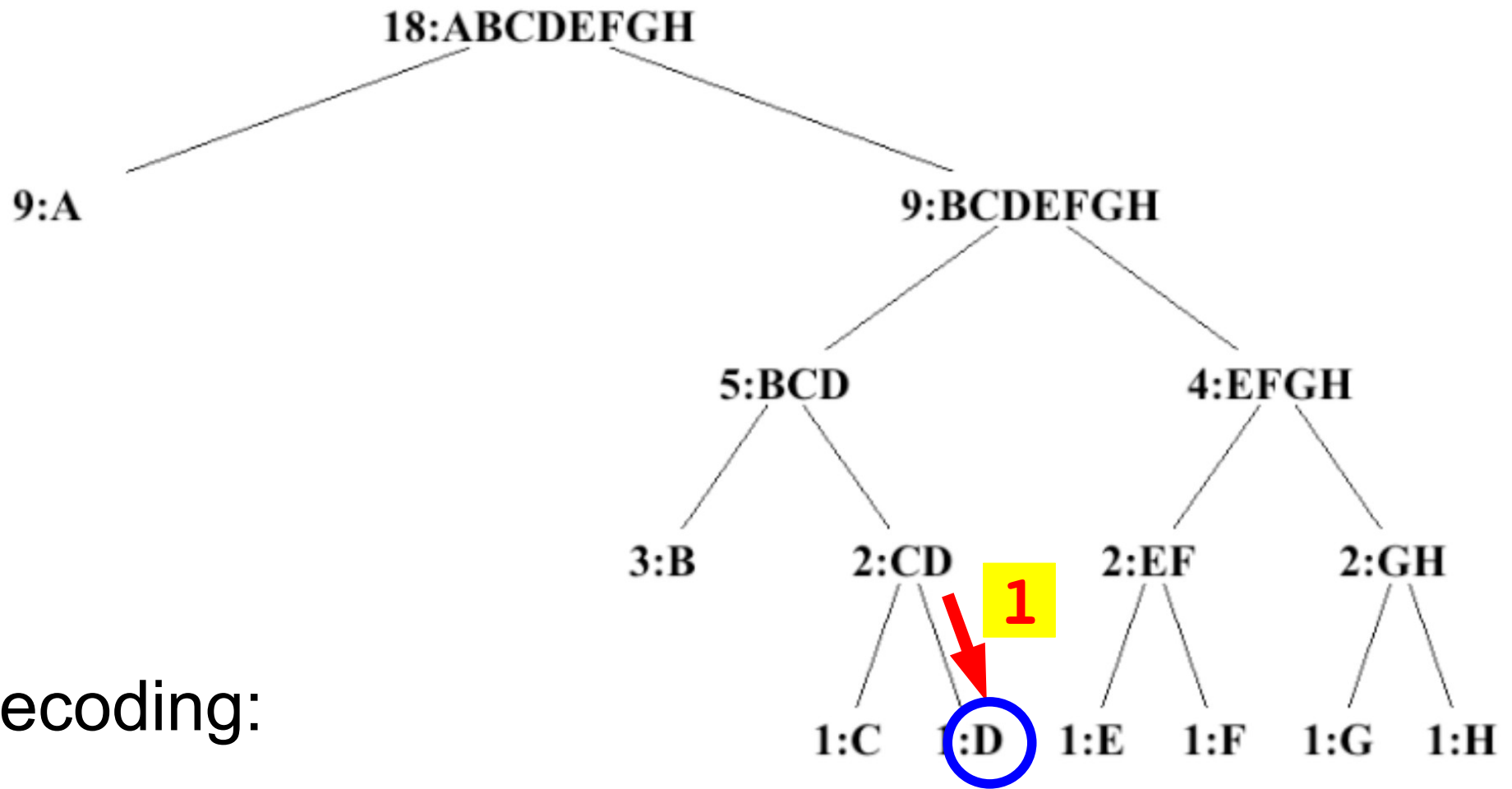

Decoding:

100010100101101100

BACAD

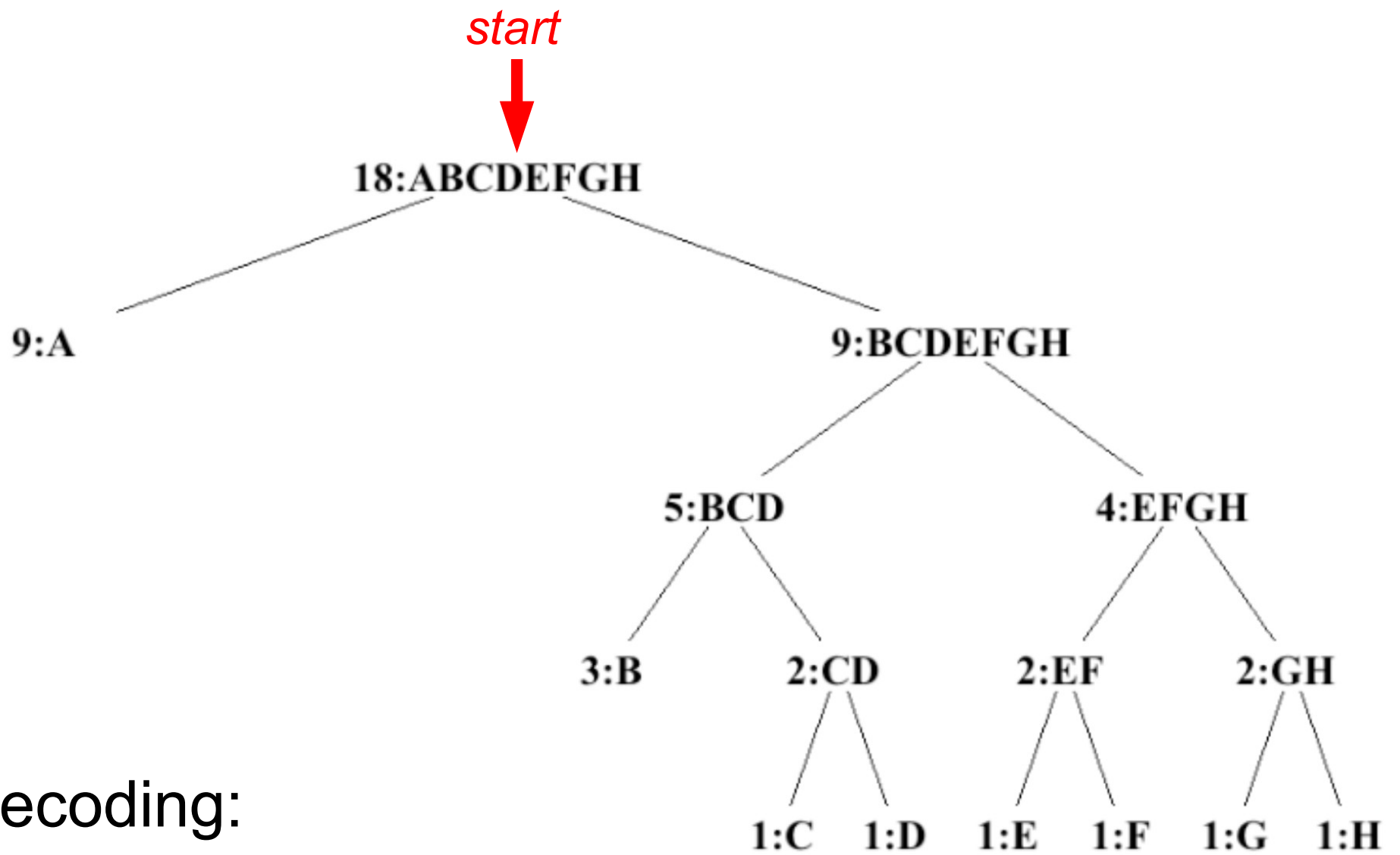

Decoding:

100010100101101100

BACAD

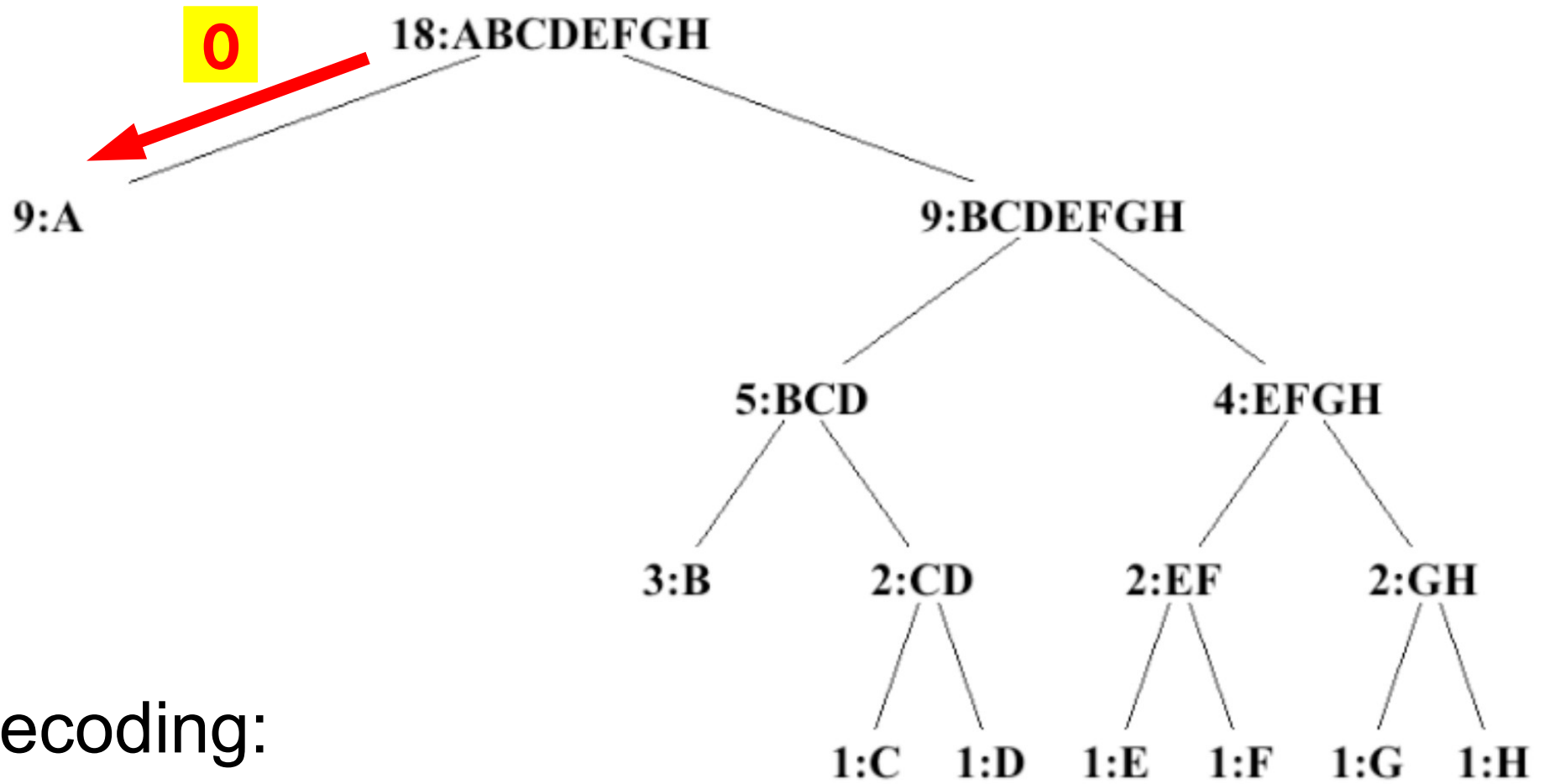

Decoding:

100010100101101100

BACAD

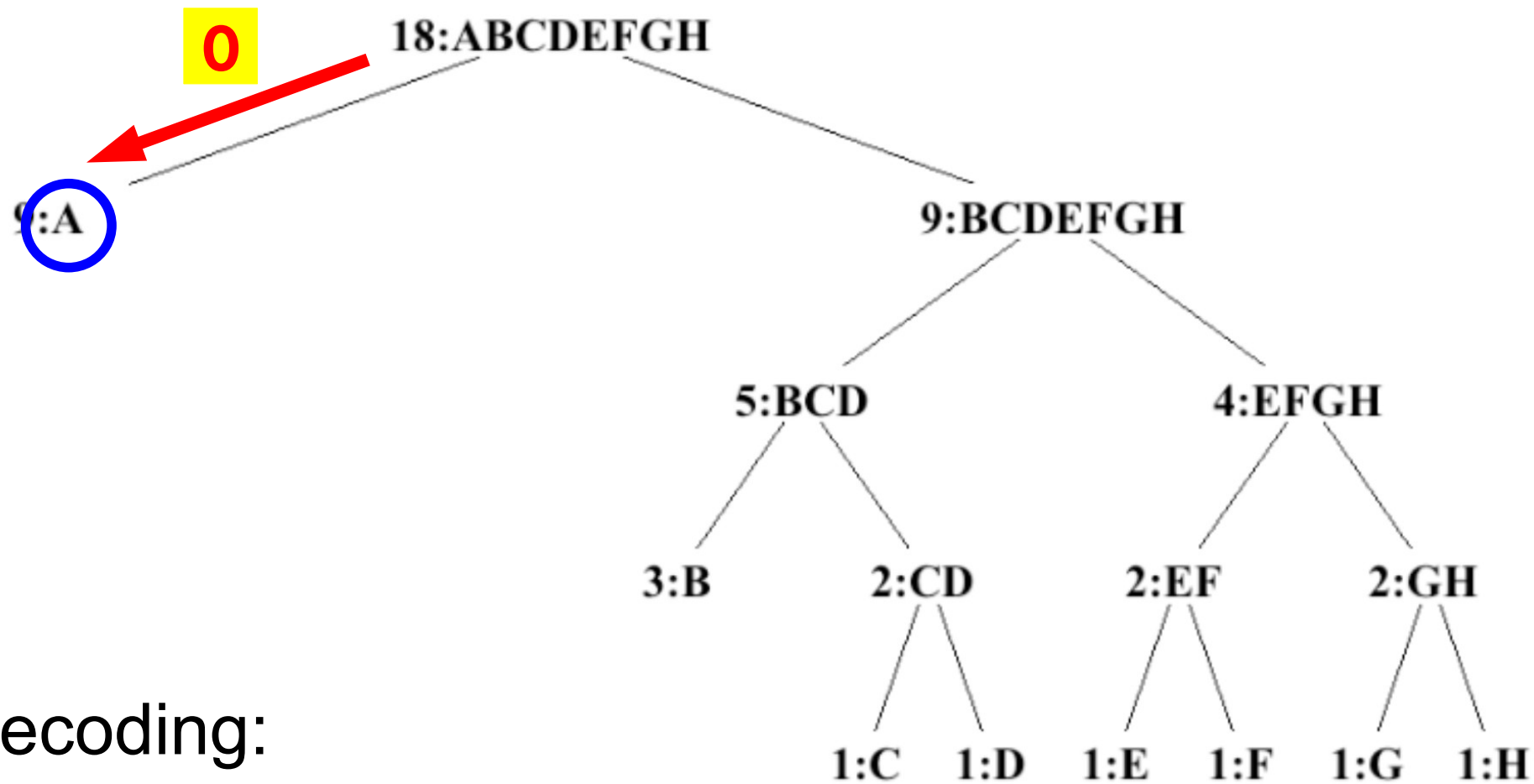

Decoding:

100010100101101100

BACADA

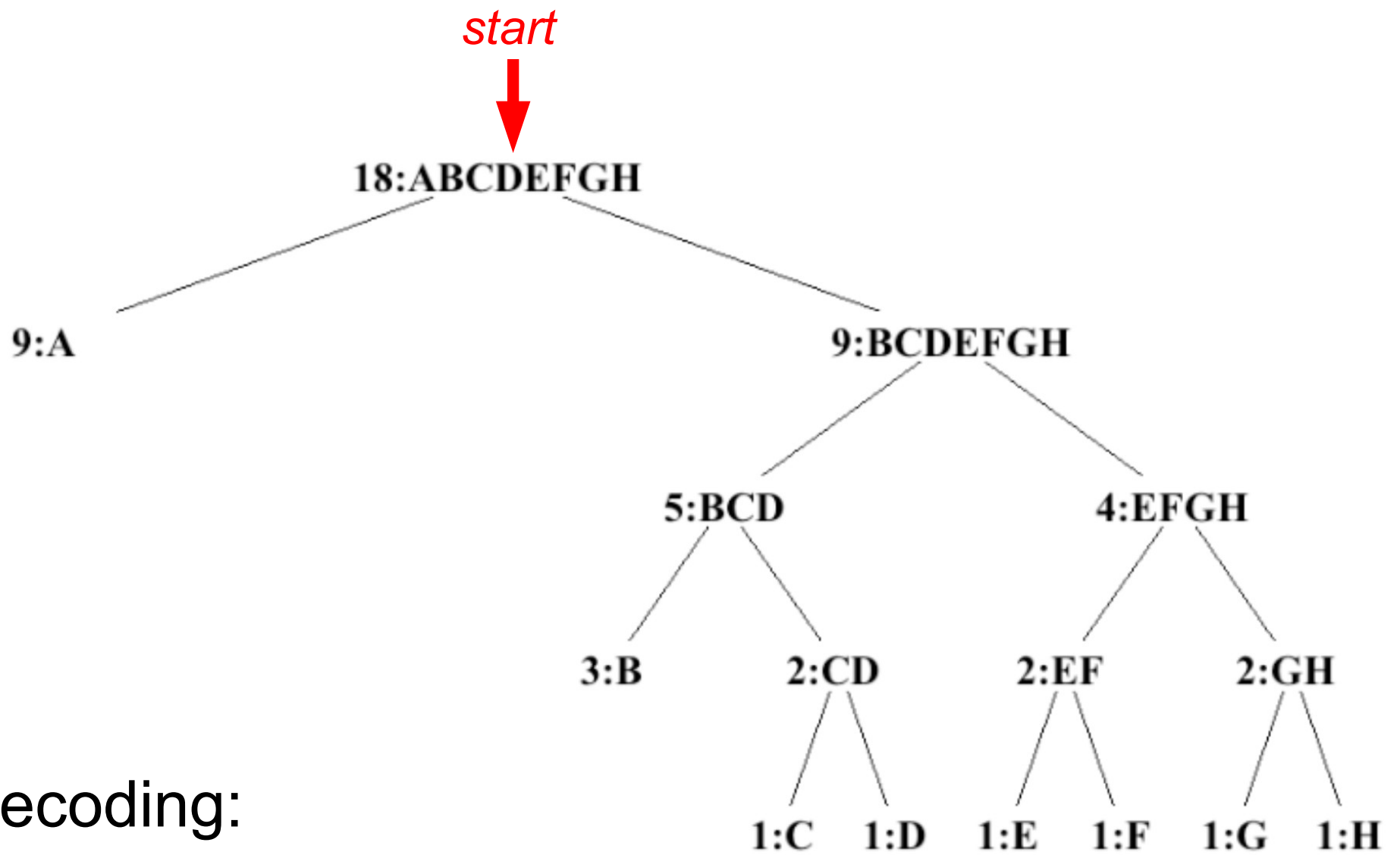

Decoding:

100010100101101100

BACADA

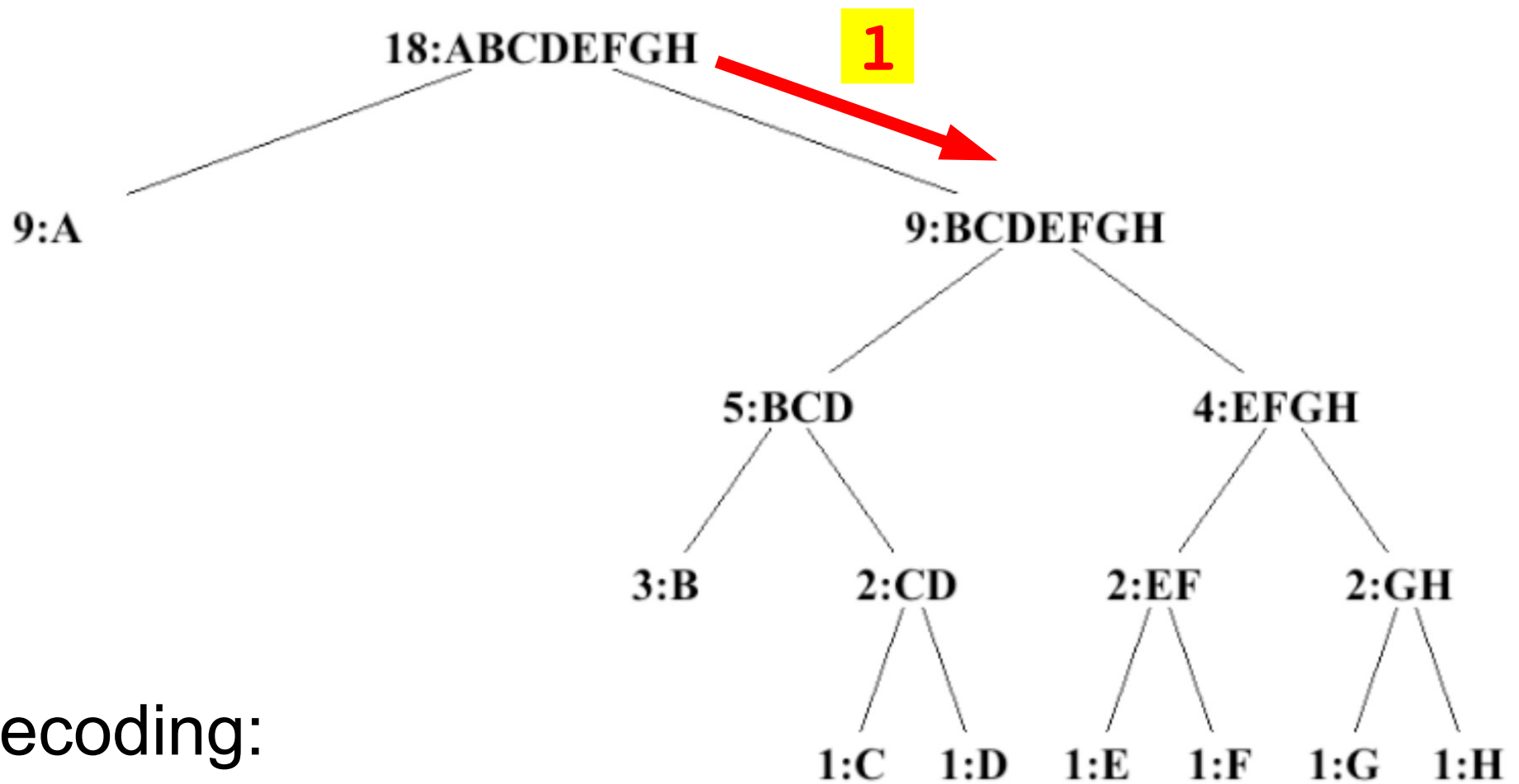

Decoding:

10001010010110**1**100

BACADA

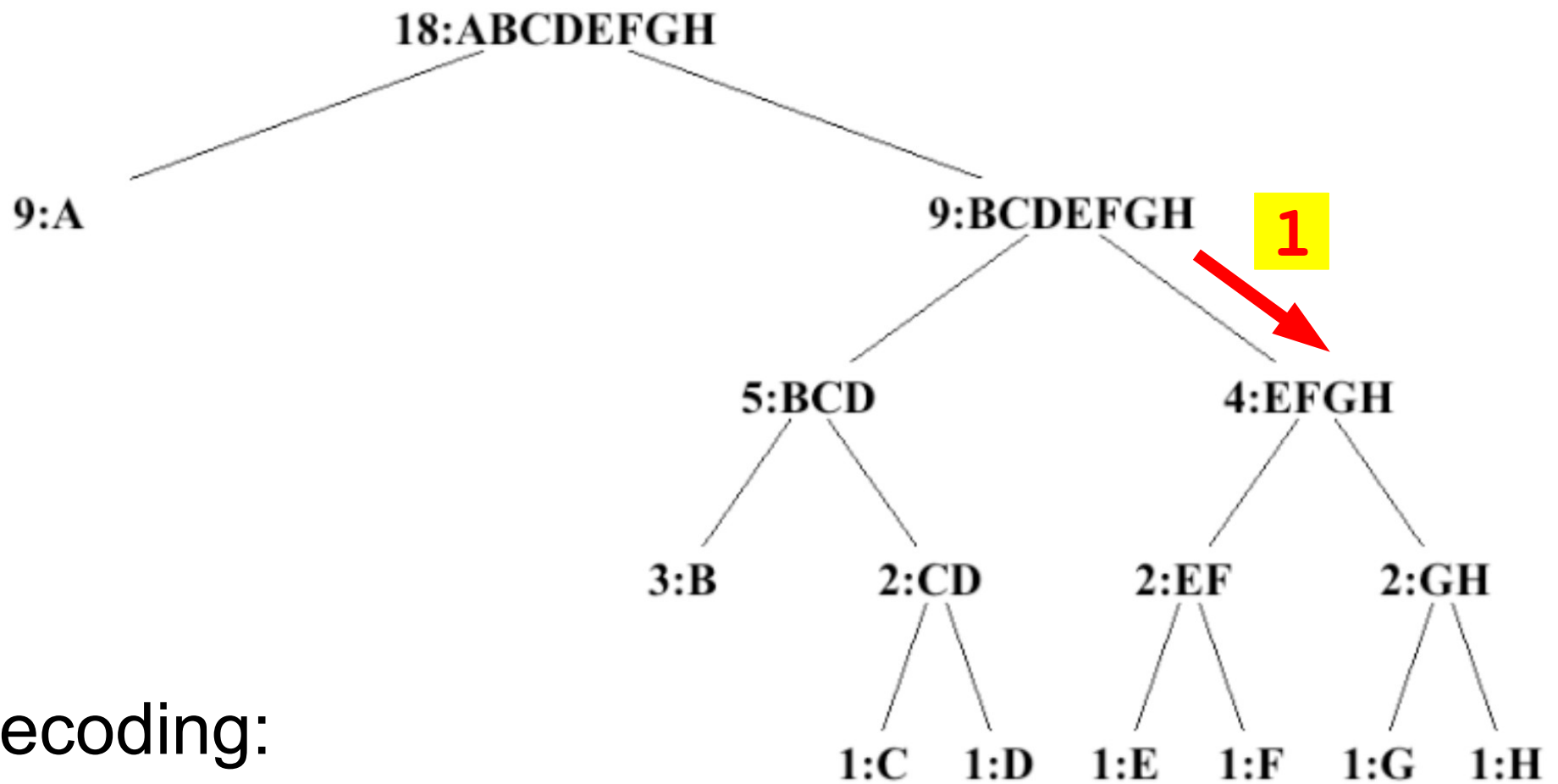

Decoding:

100010100101101100

BACADA

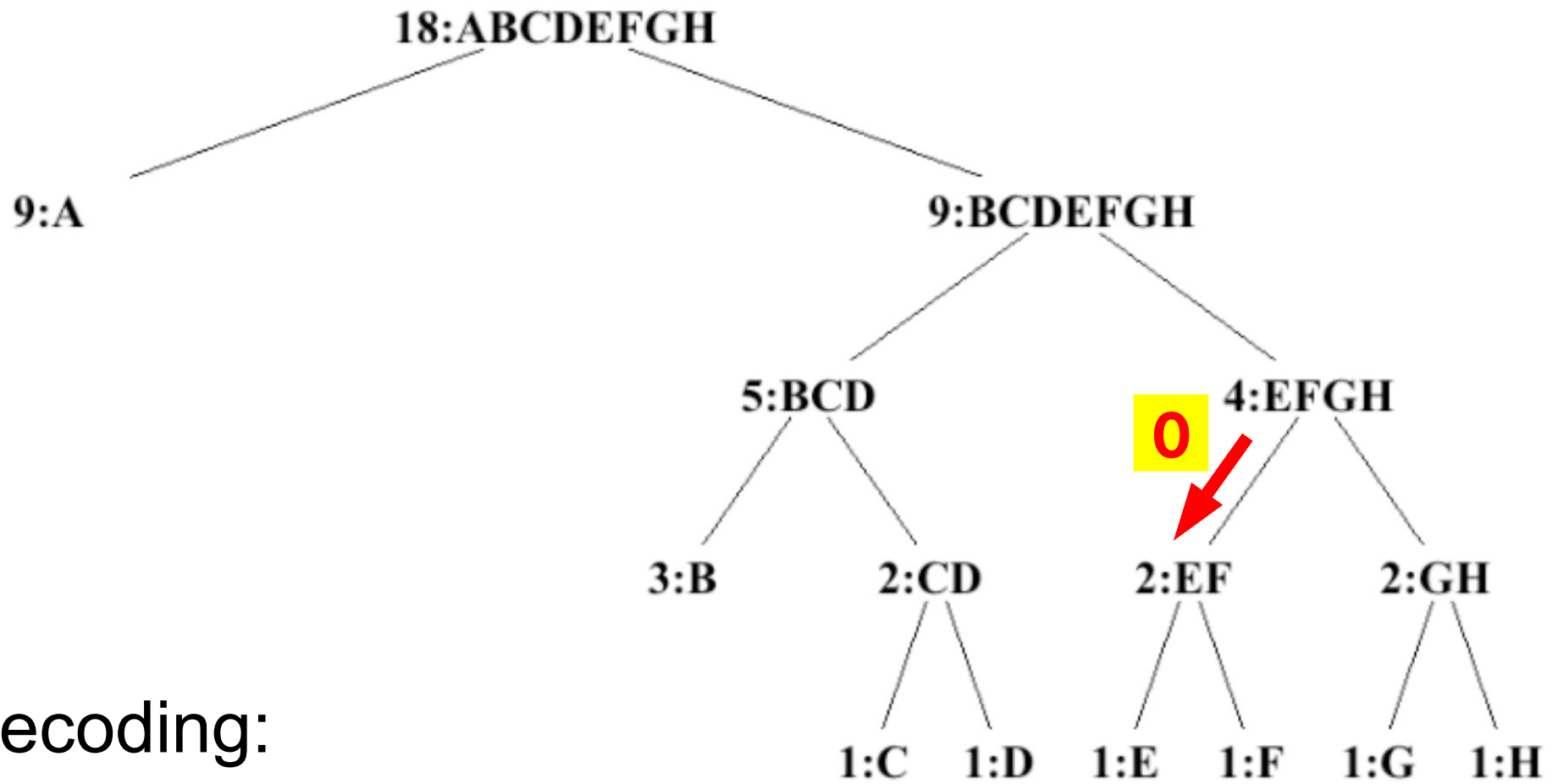

Decoding:

100010100101101100

BACADA

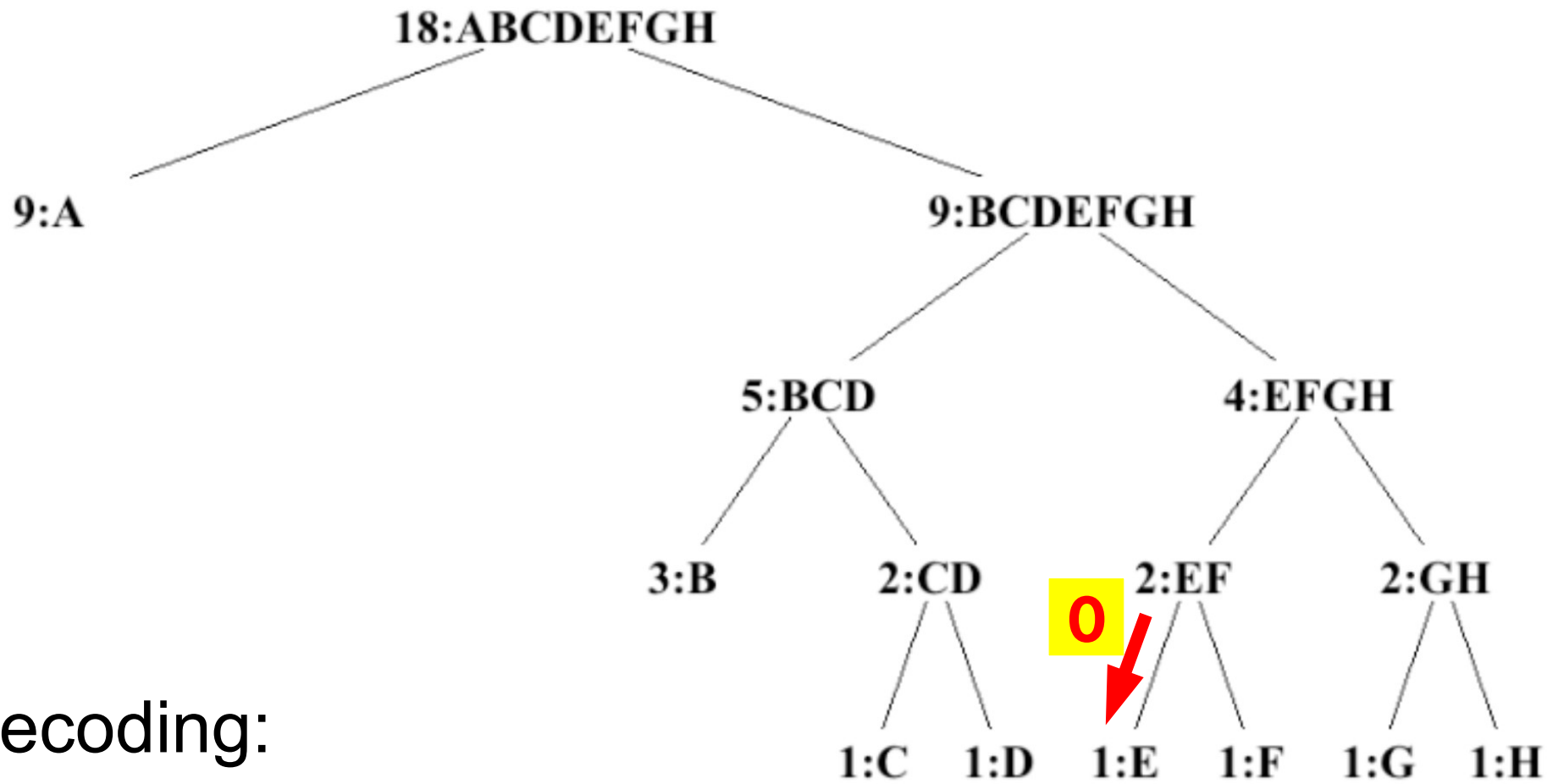

Decoding:

100010100101101100

BACADA

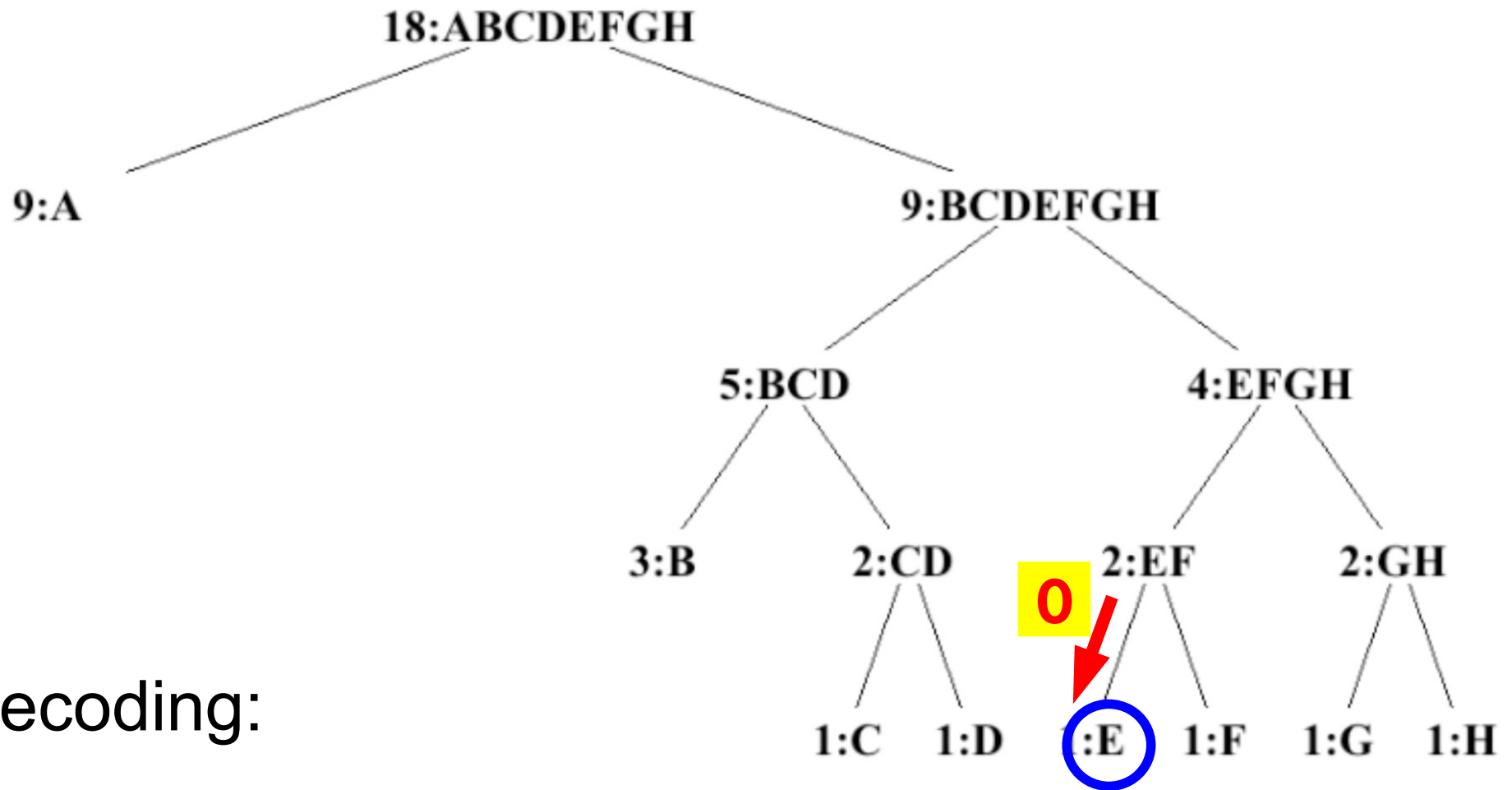

Decoding:

100010100101101100

BACADAE

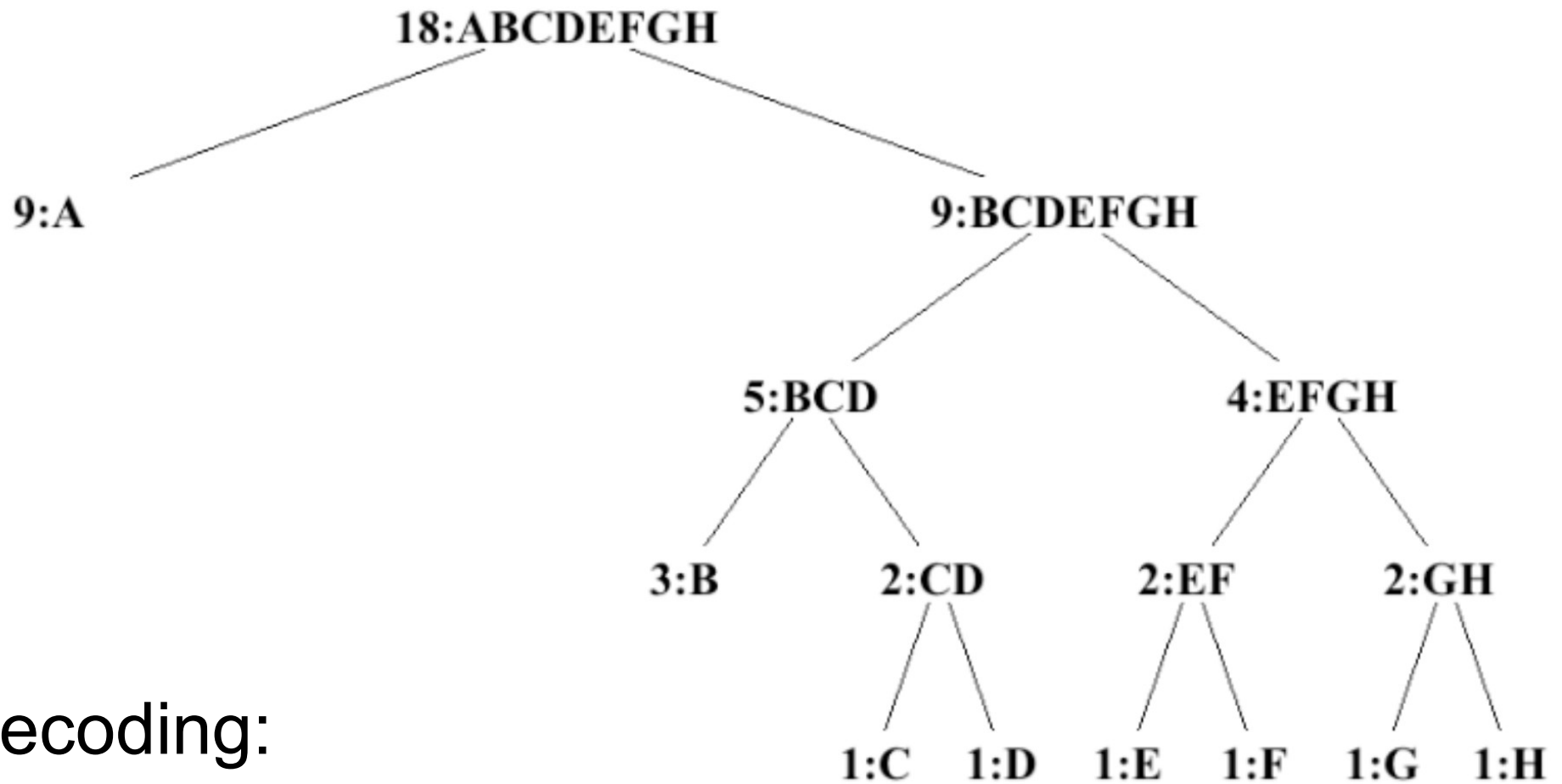

Decoding:

100010100101101100...

BACADAEAFABBAAGAHAH *... and so on*